



Free-standing Apex Veranda



T: 01933 44 88 44

E: enquiries@samsonawnings.co.uk

W: www.samsonawnings.co.uk



Free-standing Apex Veranda

Accredited to BS EN 1090 | Load tested to BS EN 1991003:2003 | Certified Non-Fragile to ACR[M] 2014:001



Size Parameters

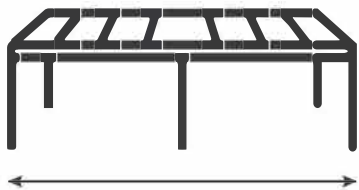

Length
Any Length

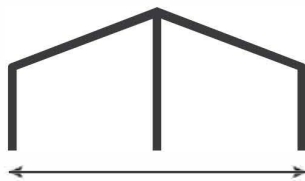

Width
Max 12m (polycarbonate roof)
Max 10m (glass roof)

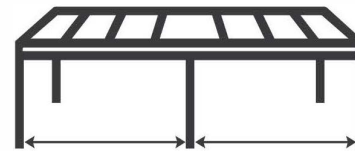

Span Between Front Posts
Max 4m

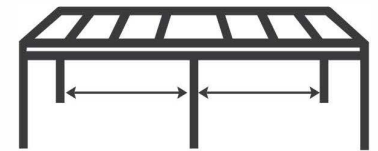

Span Between Back Posts
Max 6m



Free-standing Apex Veranda



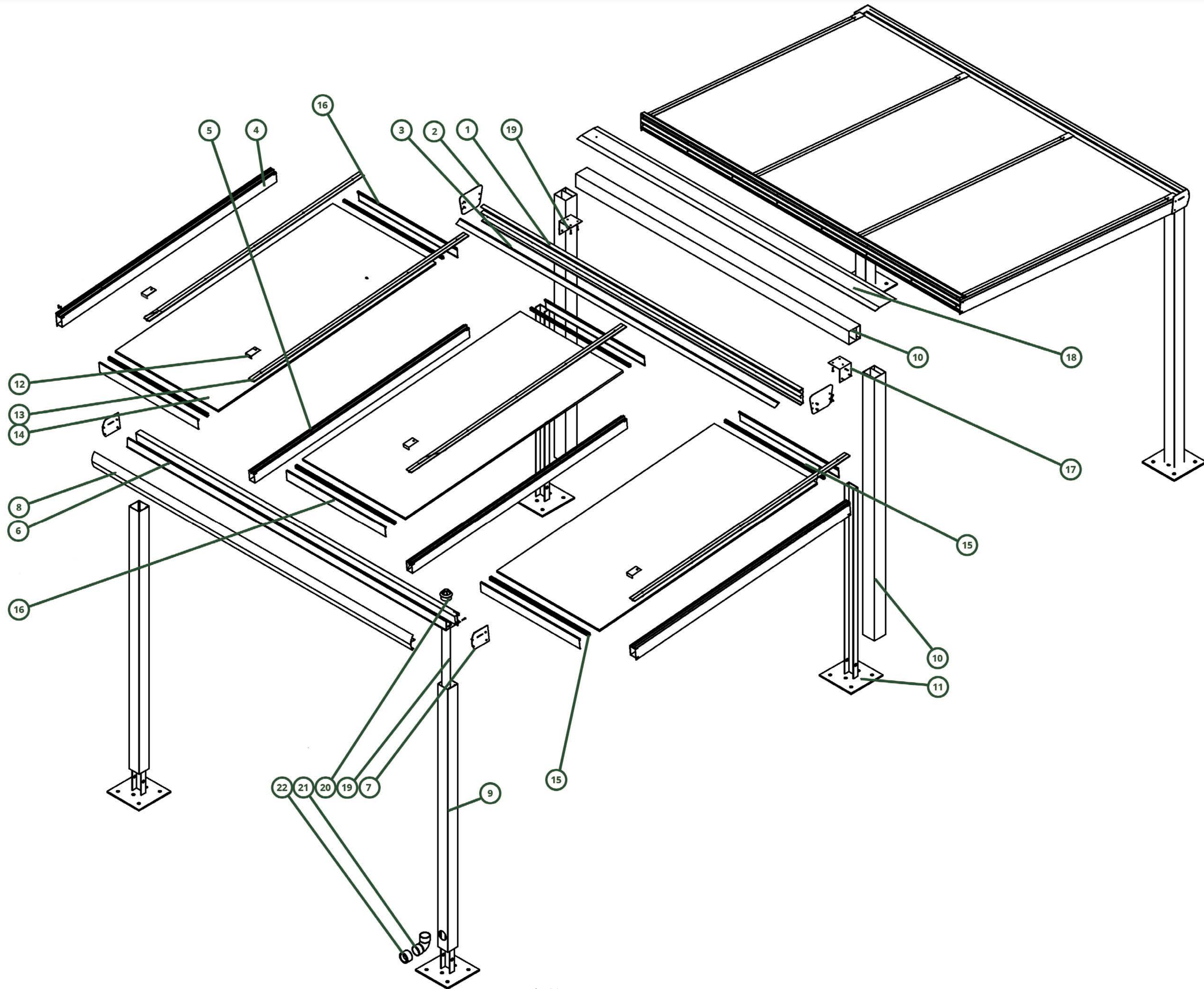



Exploded Drawing



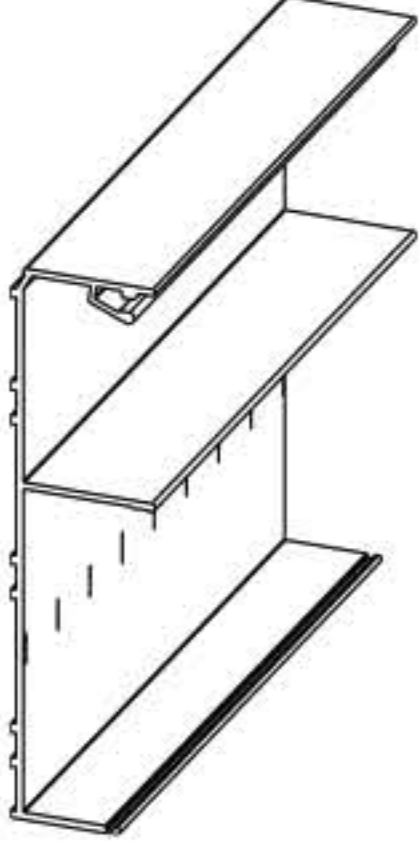
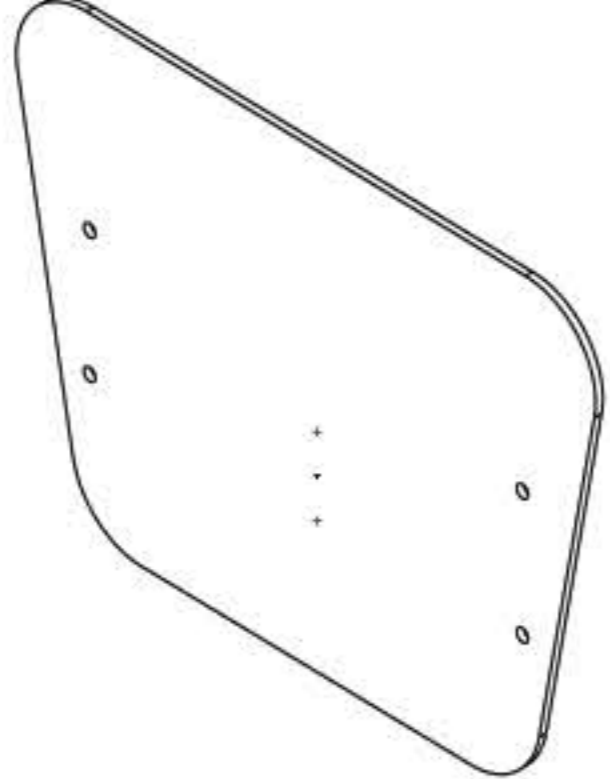

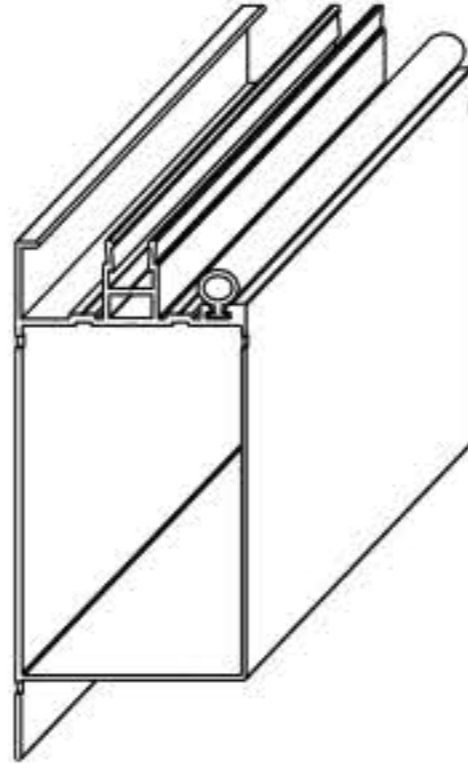
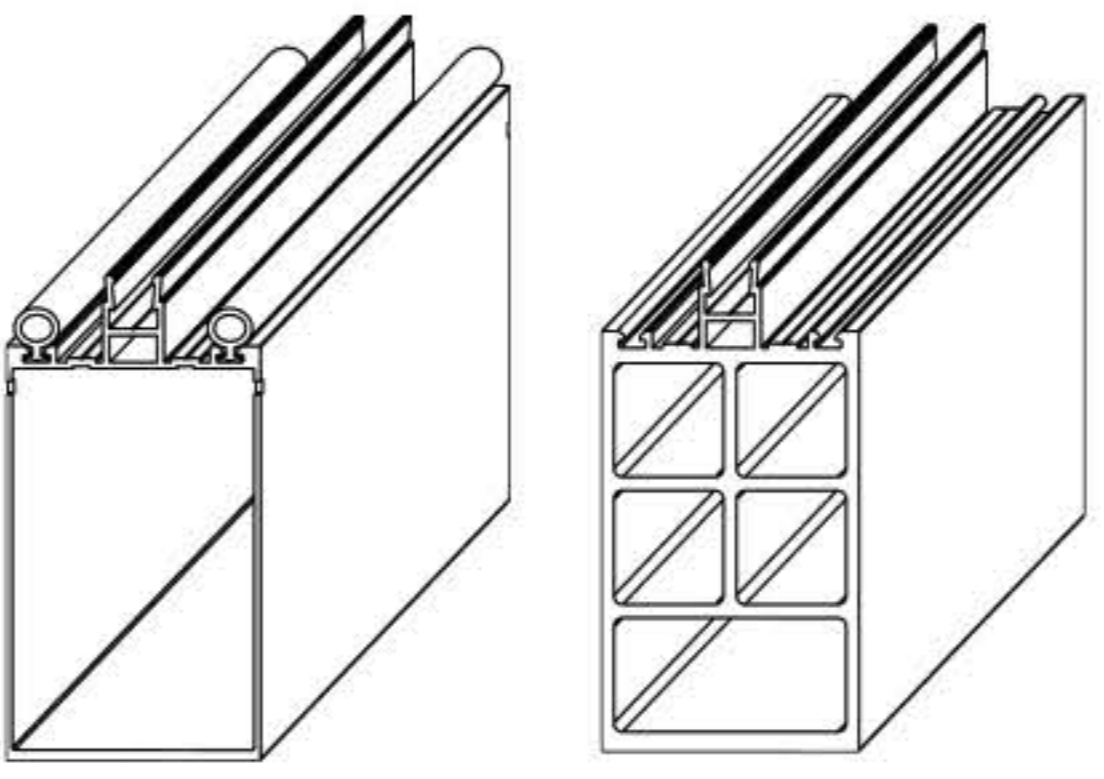
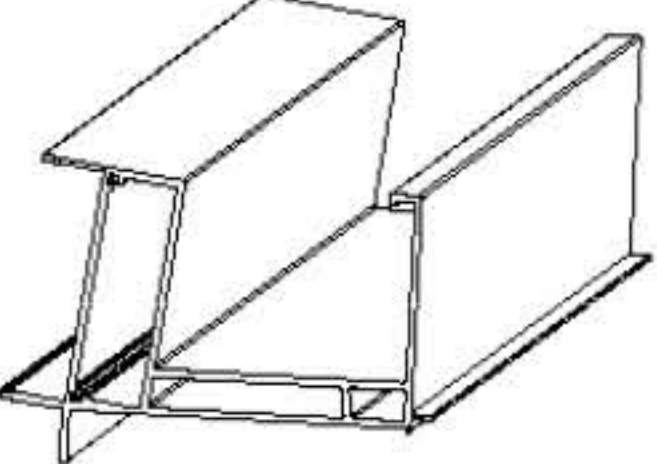
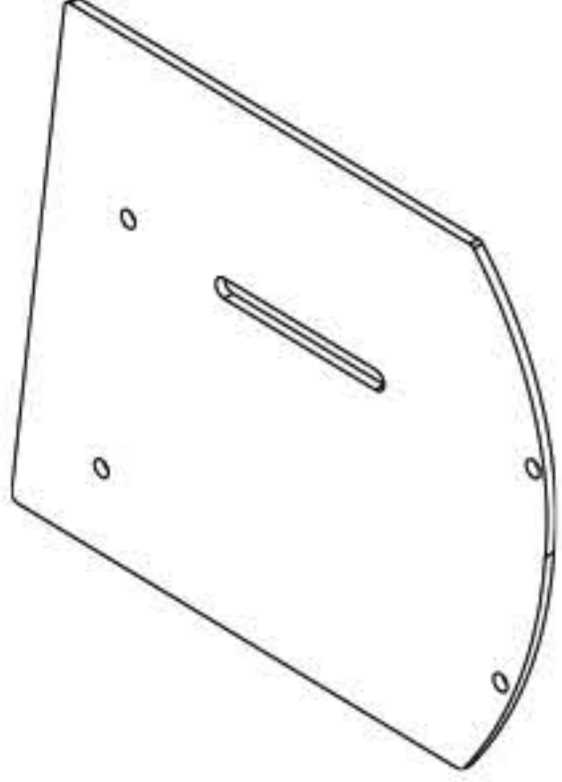
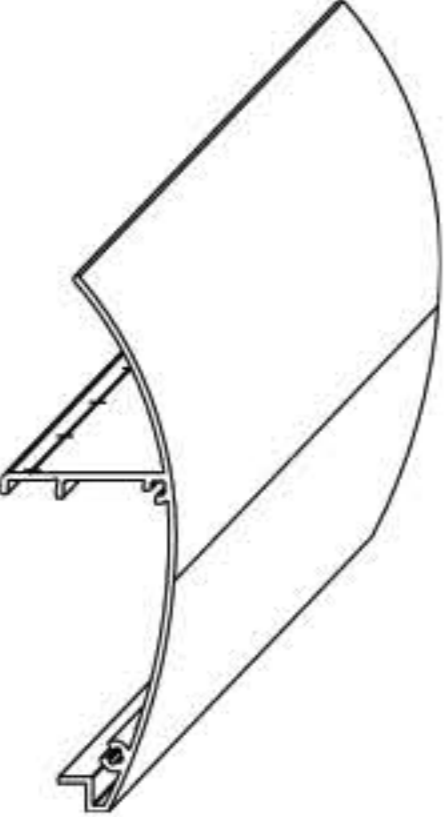
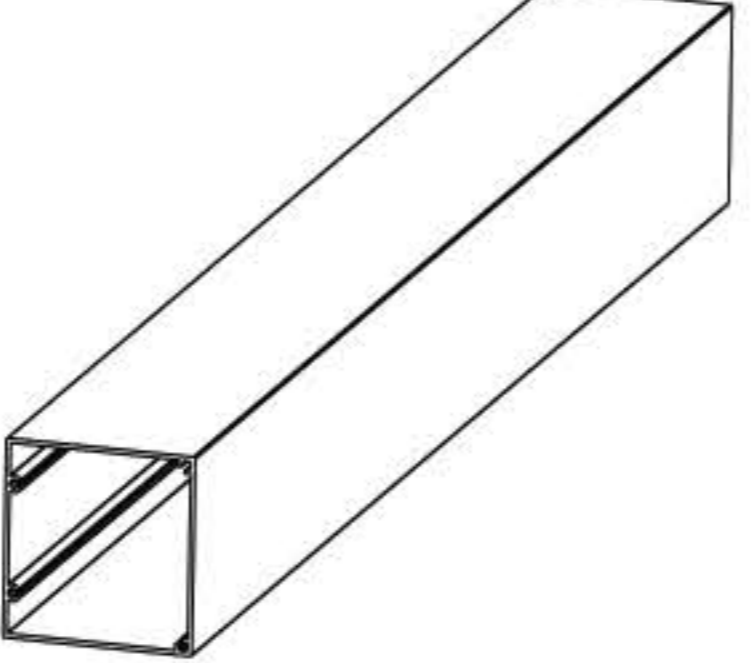
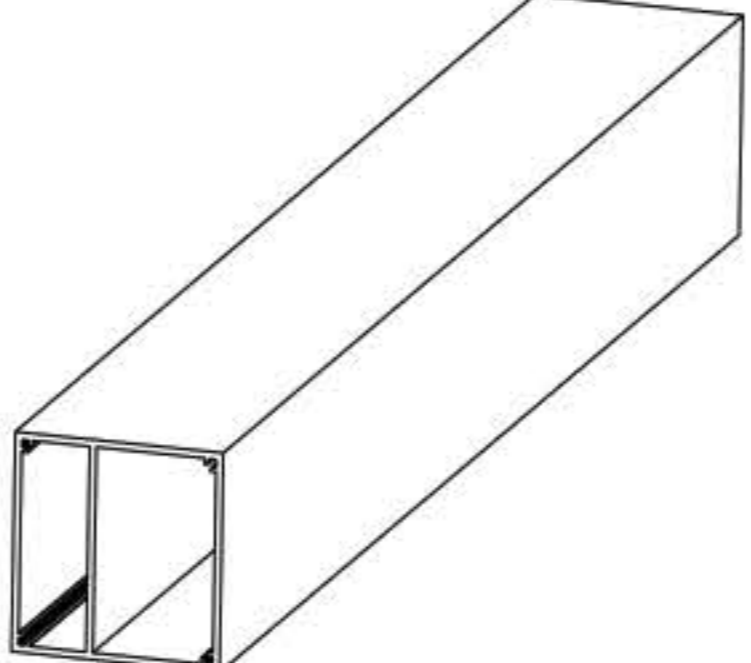
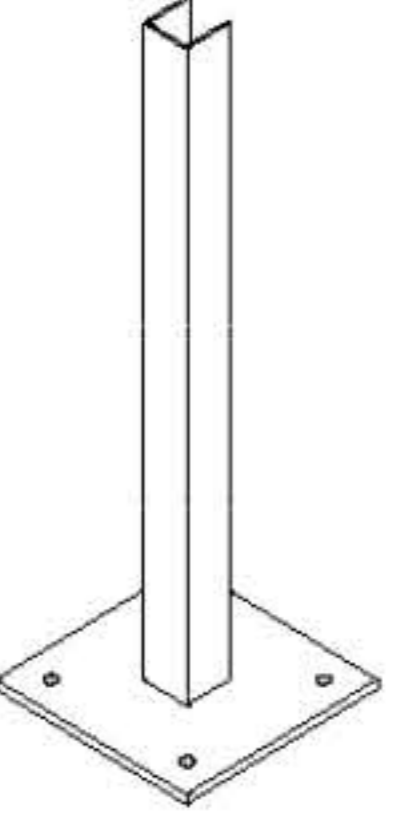
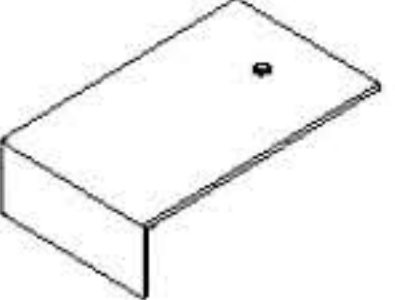
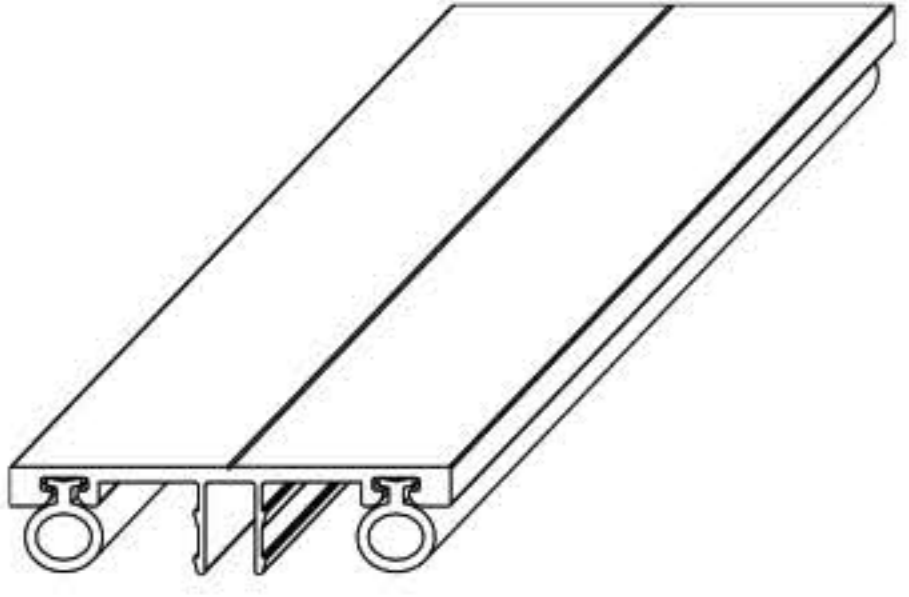
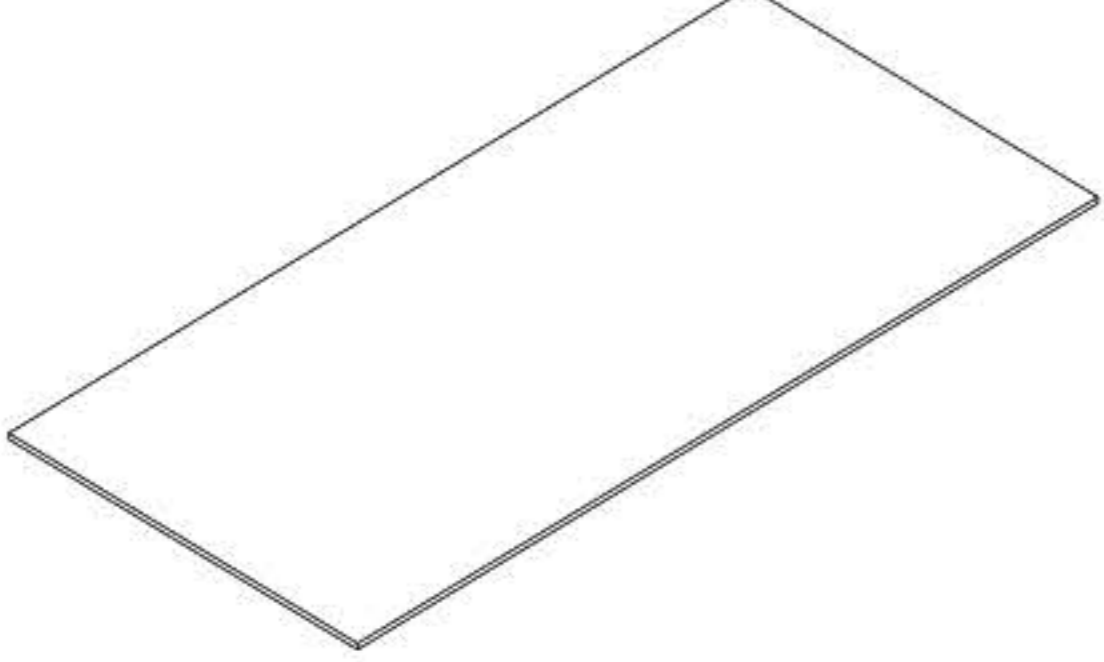
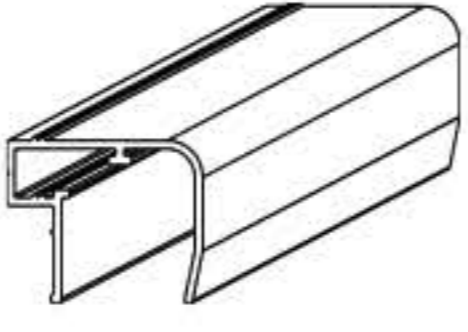
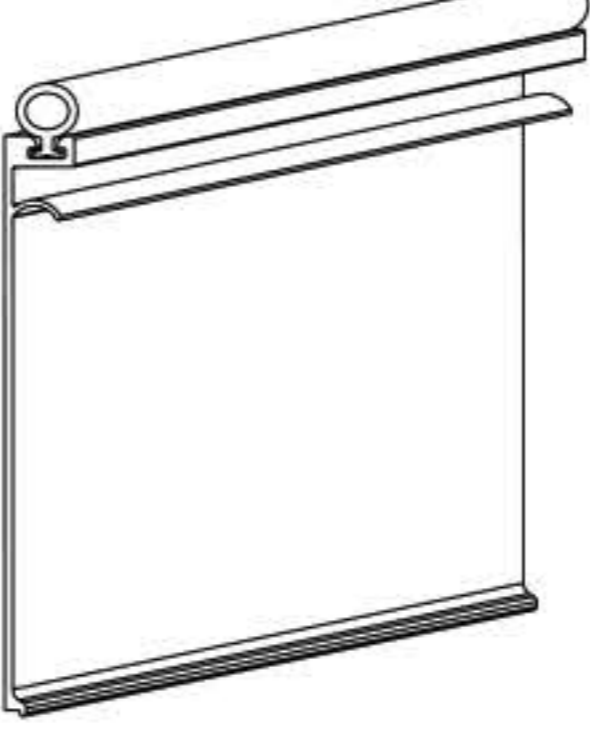
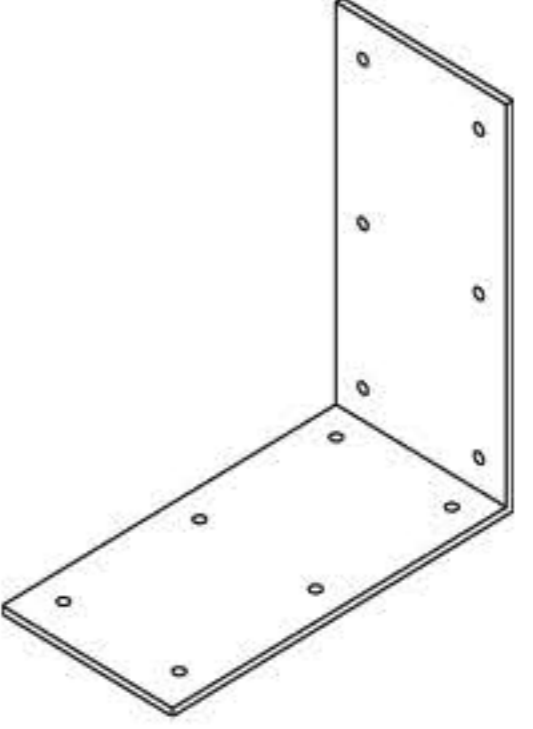
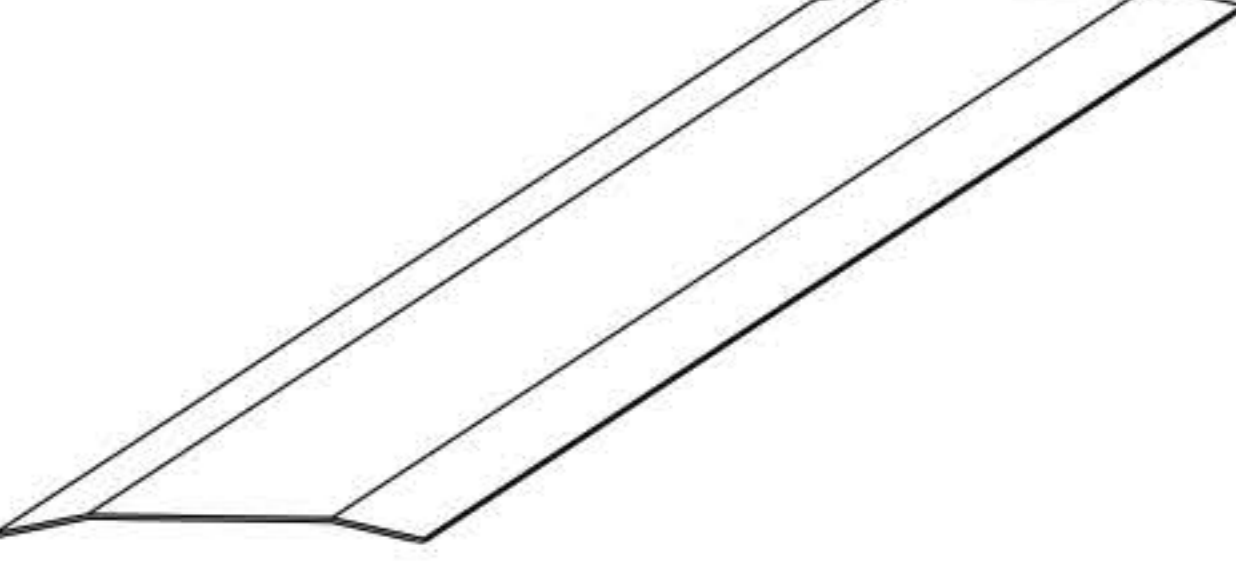
Free-standing Apex Veranda

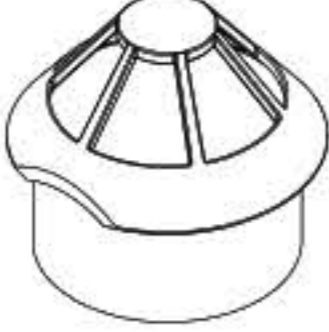
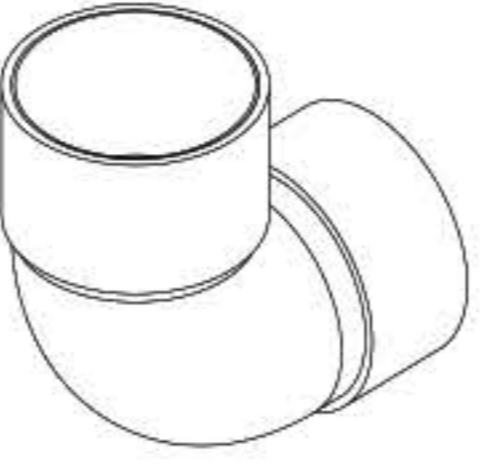
Part List

 <p>1. Wall Plate</p>	 <p>2. End Cap</p>	 <p>3. Wall Plate Rubber</p>	 <p>4. Side Roof Beam</p>	 <p>5. Intermediate Roof Beam</p>	 <p>6. Gutter</p>
 <p>7. Gutter End Cap</p>	 <p>8. Gutter Fascia</p>	 <p>9. 110 x 110mm Square Post</p>	 <p>10. 125 x 125mm Square Post</p>	 <p>11. Base Plate</p>	 <p>12. Roof Beam End Plate</p>
 <p>13. Roof Beam Top Cap</p>	 <p>14. Roof Panel</p>	 <p>15. Nosing (Polycarbonate Only)</p>	 <p>16. Infill Fascia</p>	 <p>17. L Bracket</p>	 <p>18. Apex Flashing</p>
 <p>19. Down Pipe</p>	 <p>20. Leaf Guard</p>	 <p>21. Elbow</p>	 <p>22. Elbow End Cover</p>		

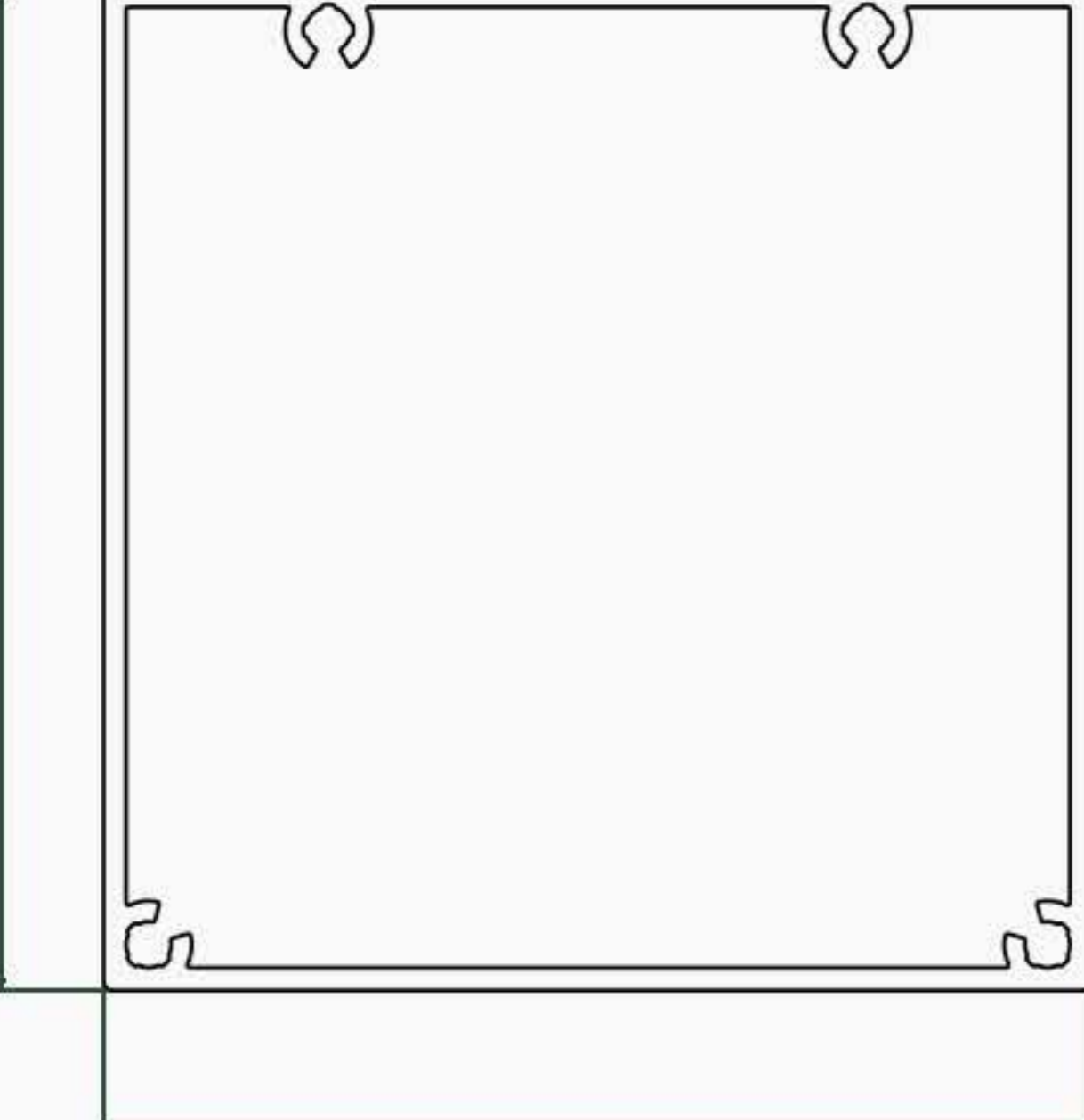
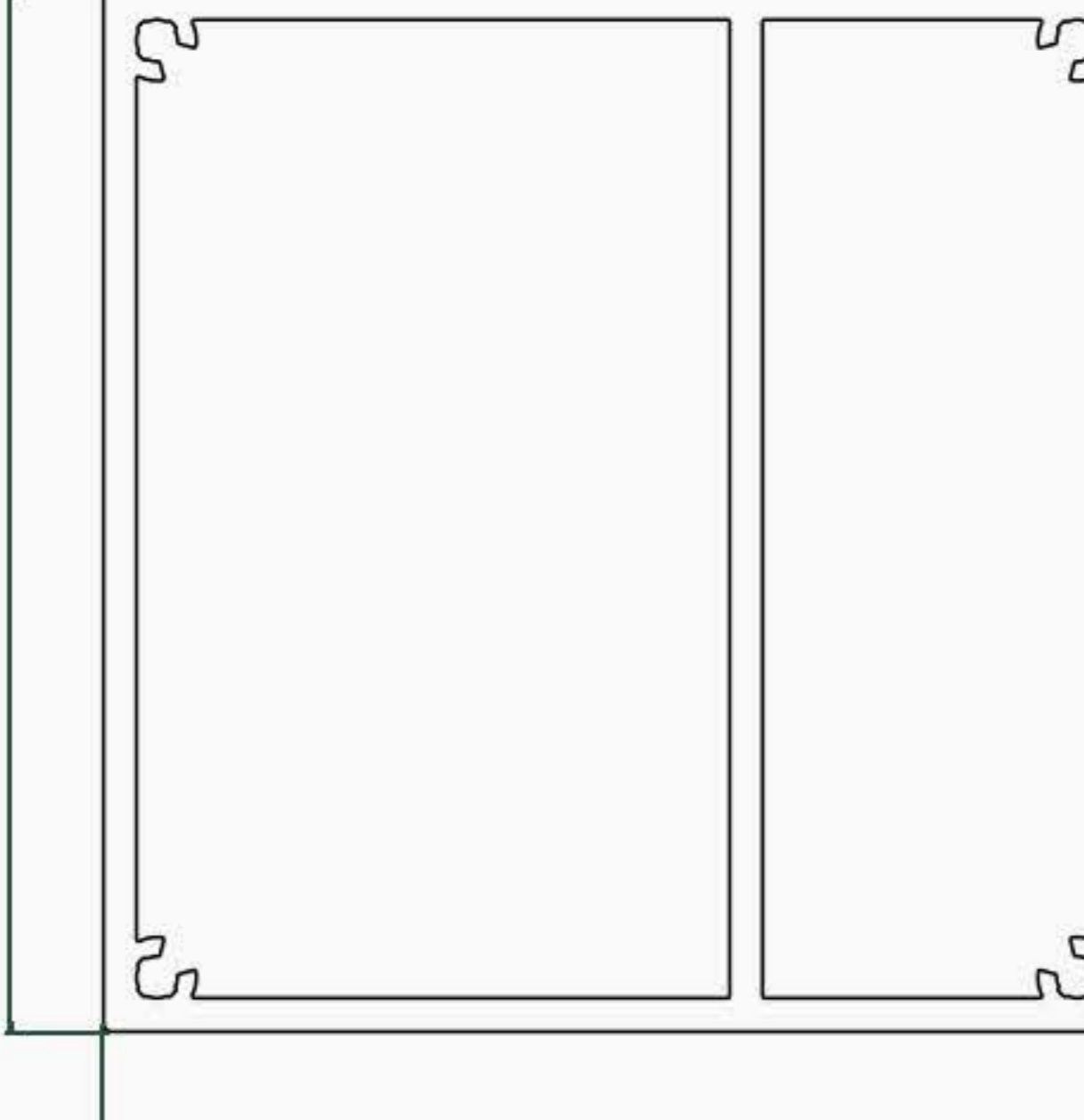
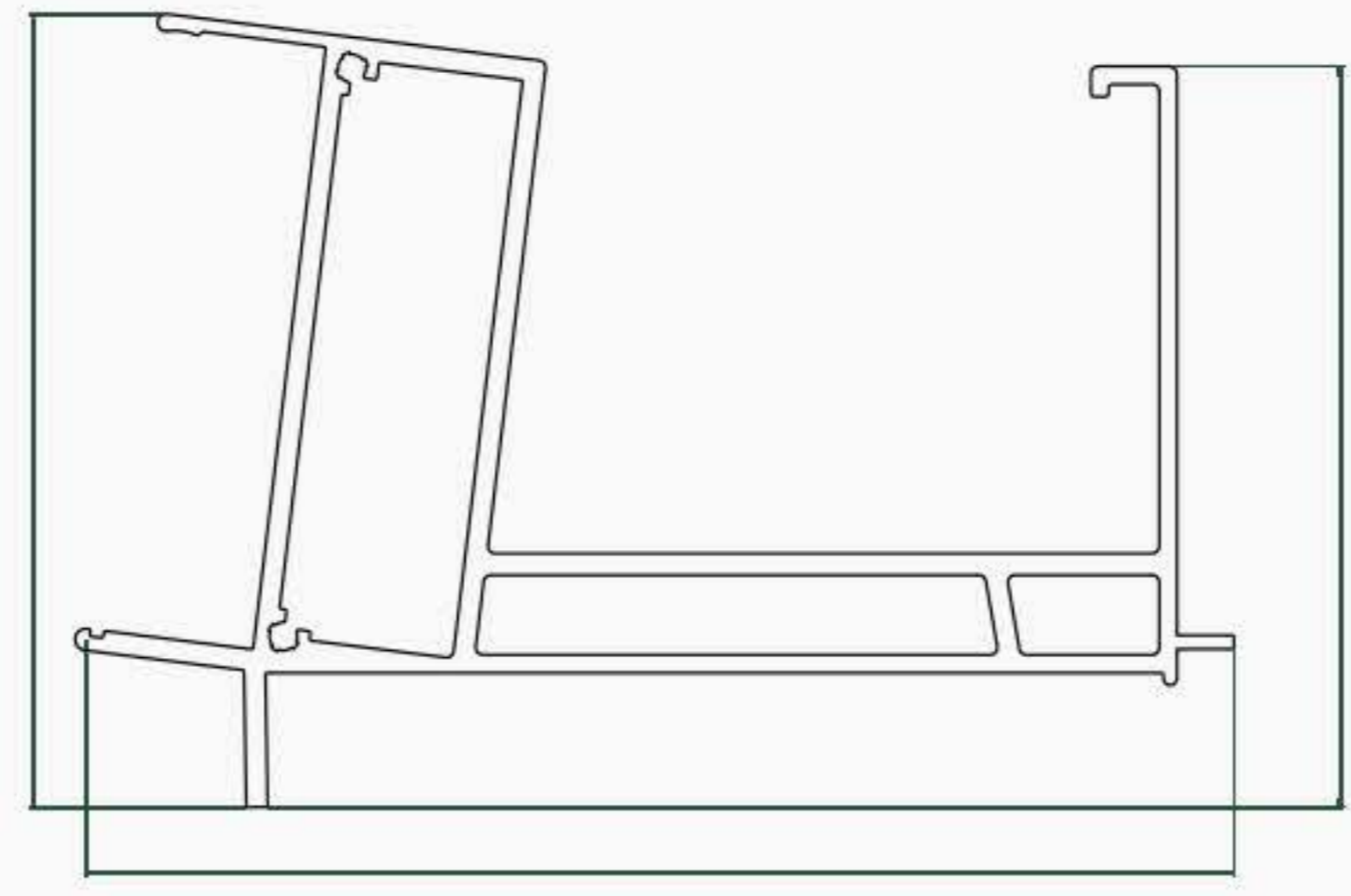
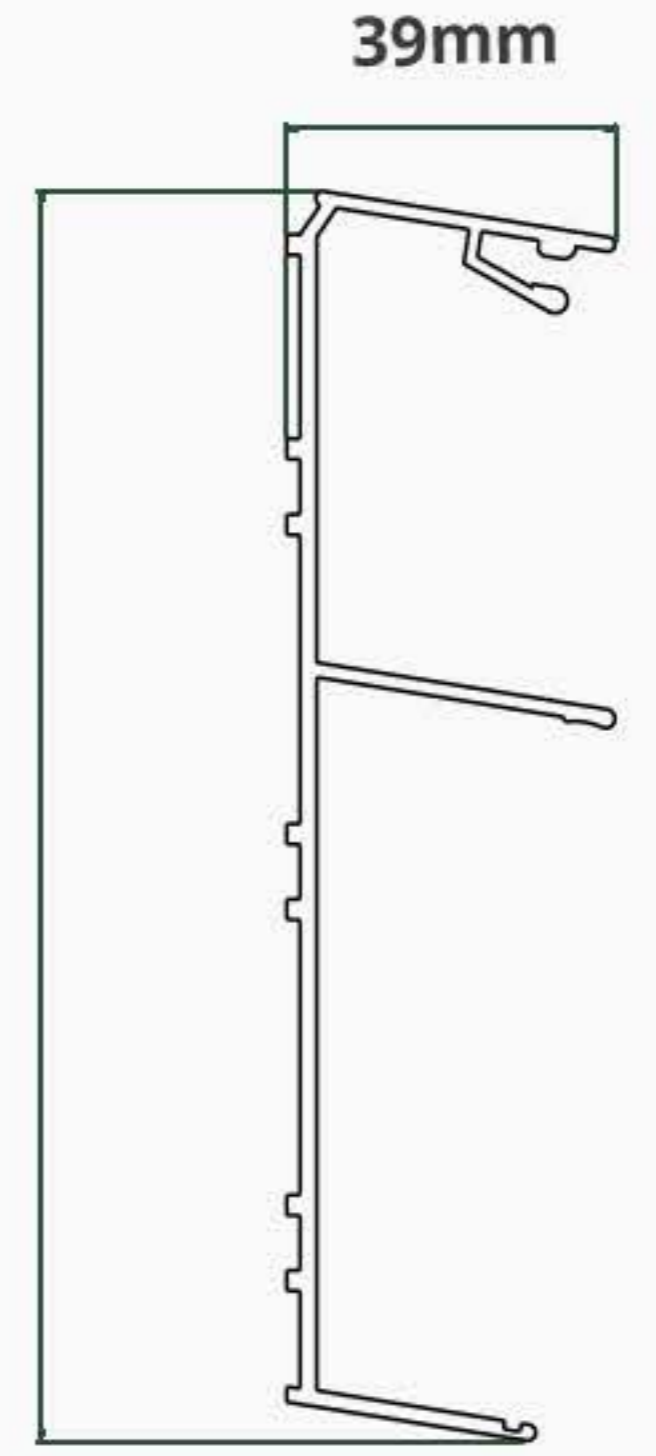
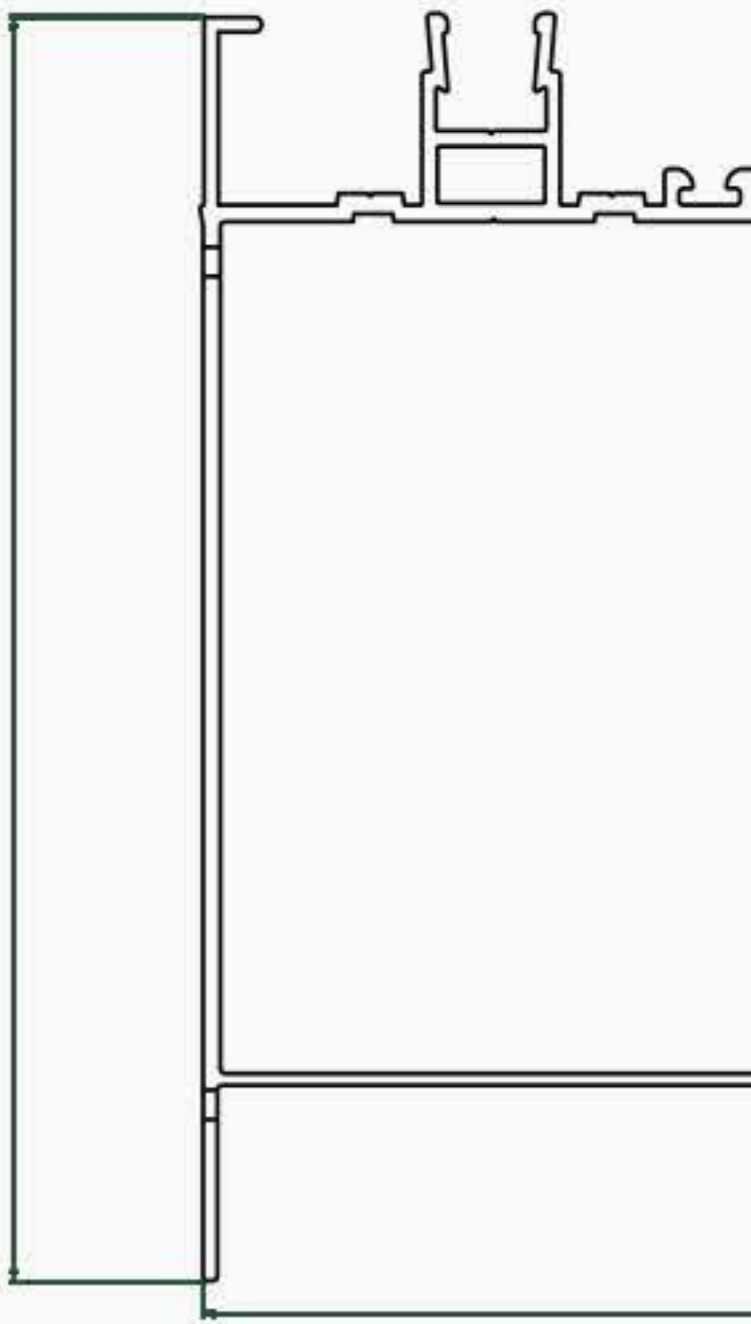
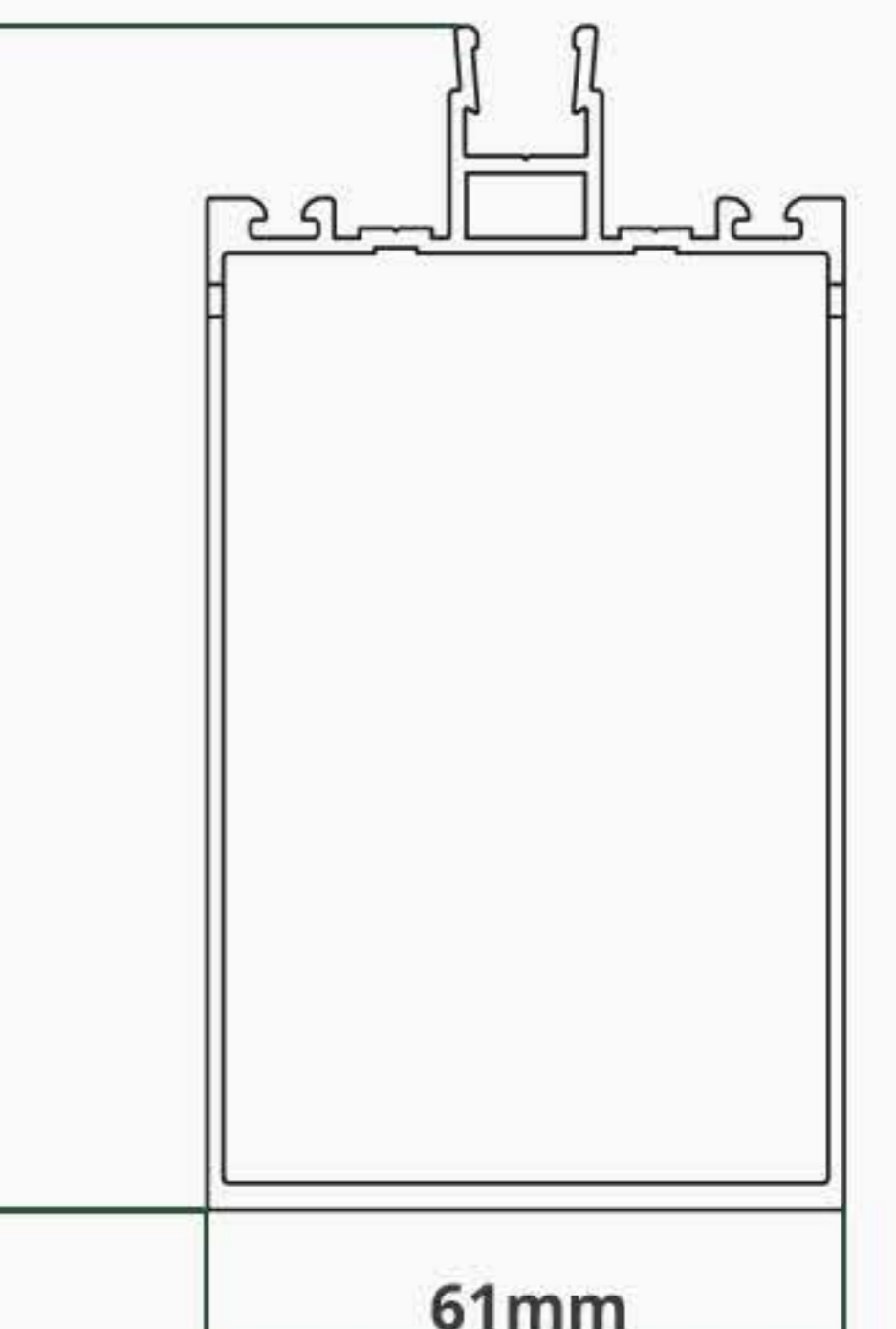
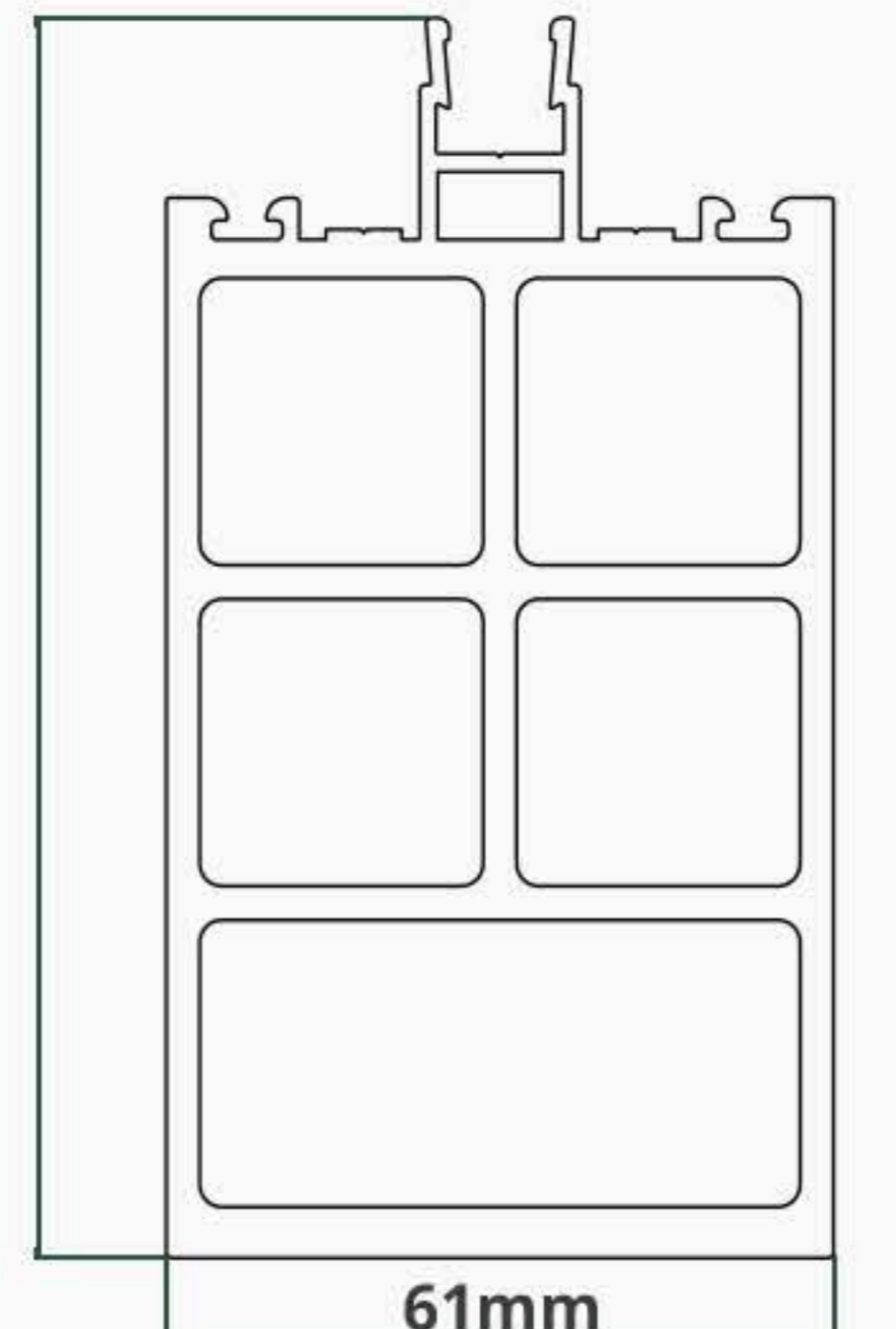
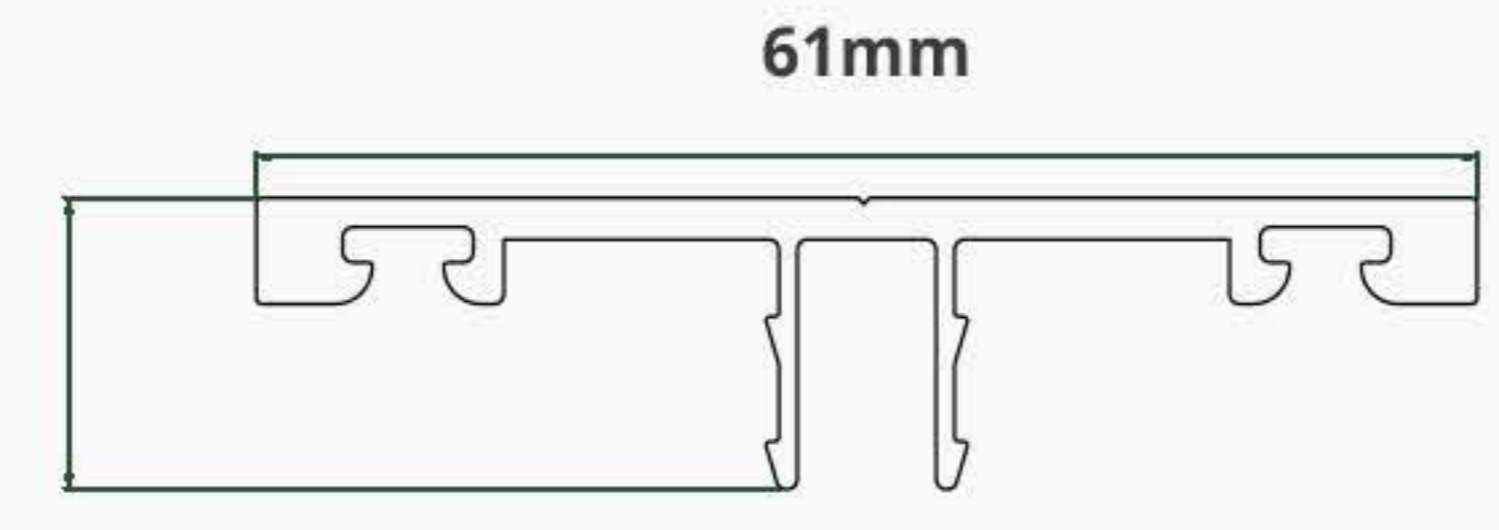
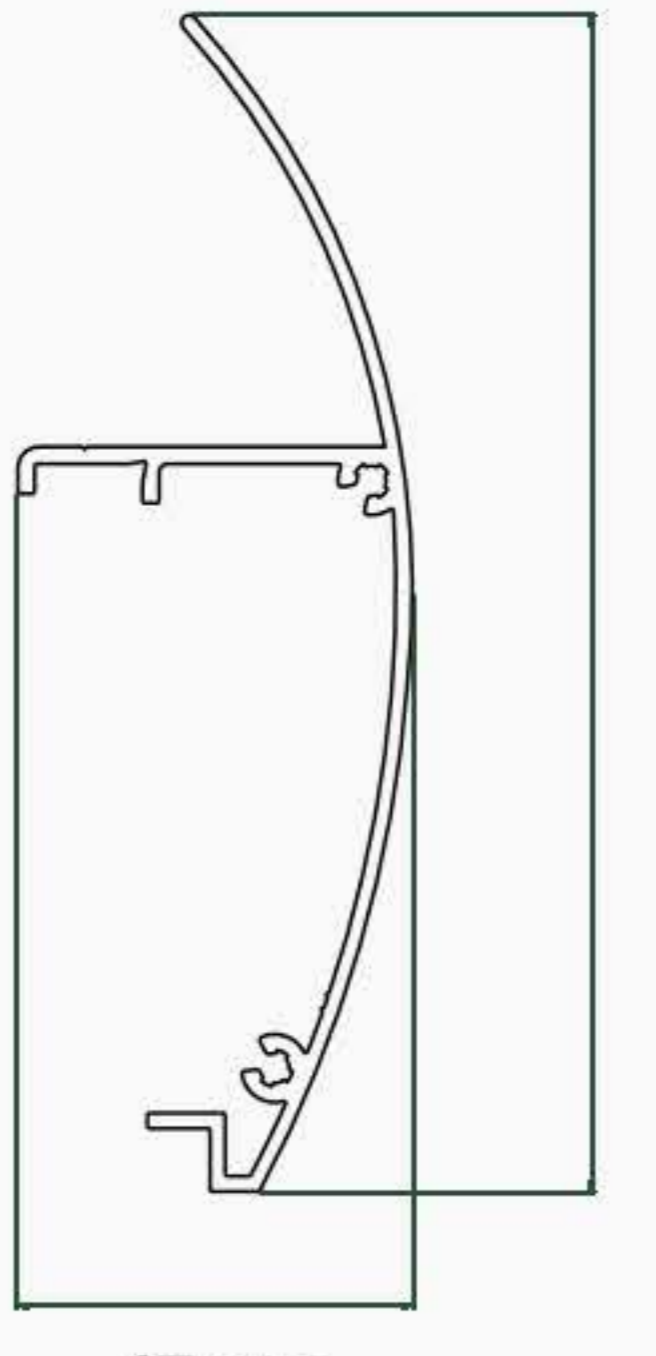
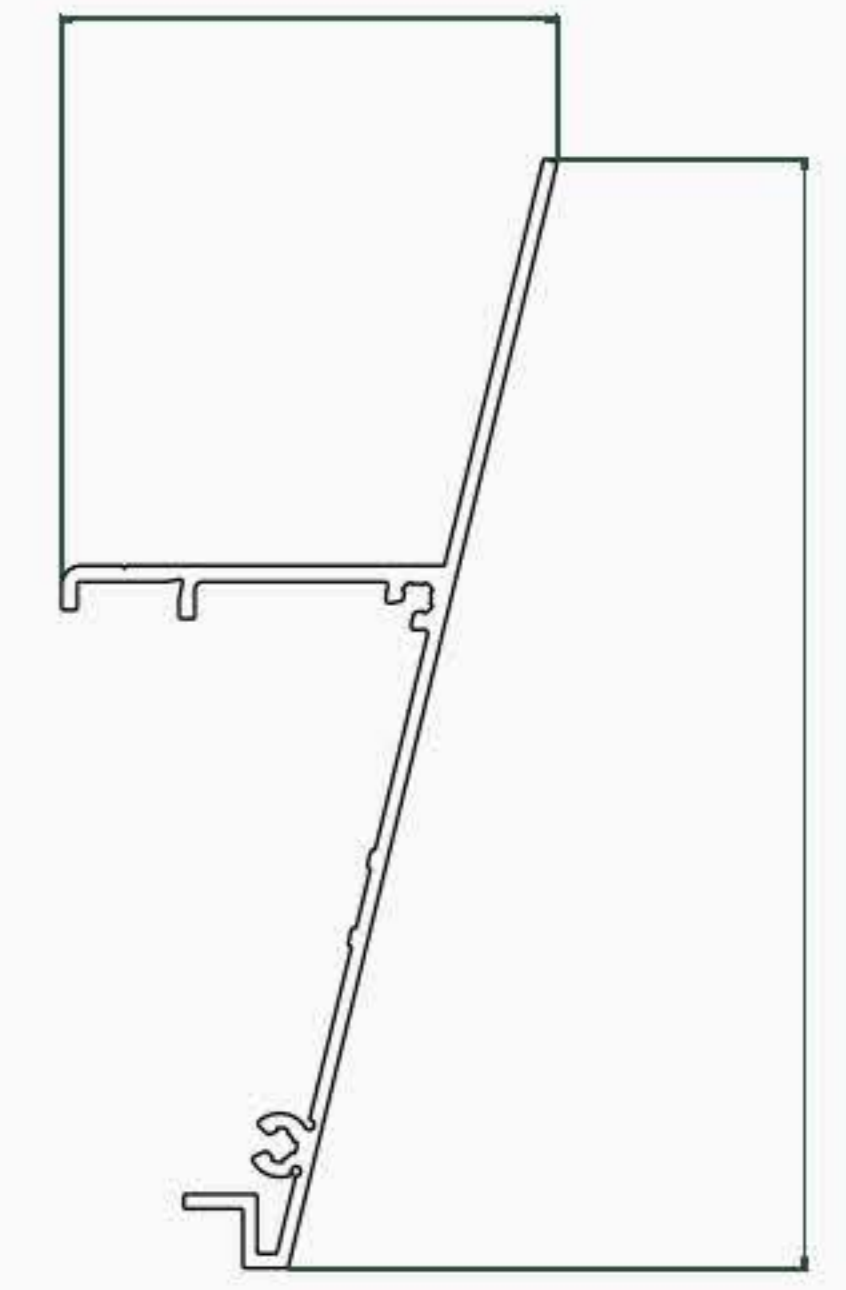
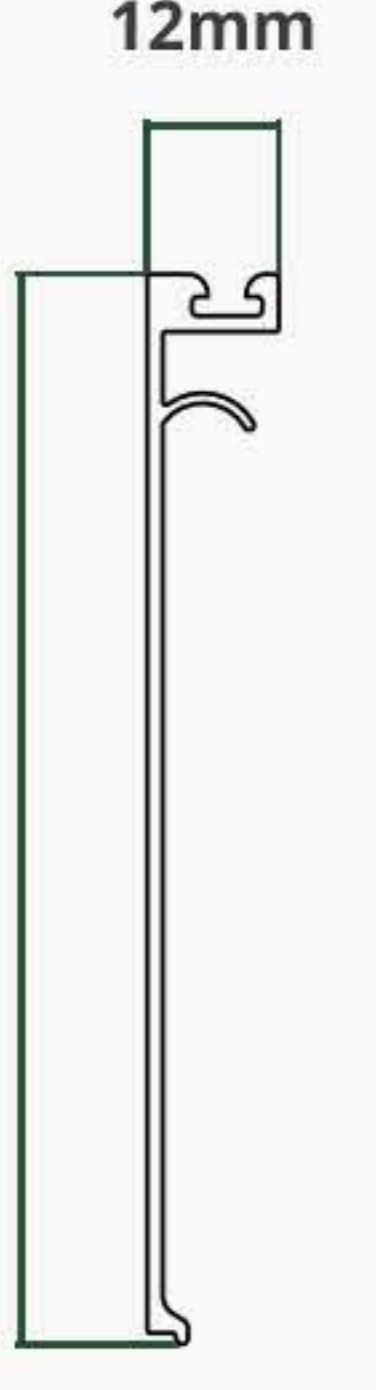
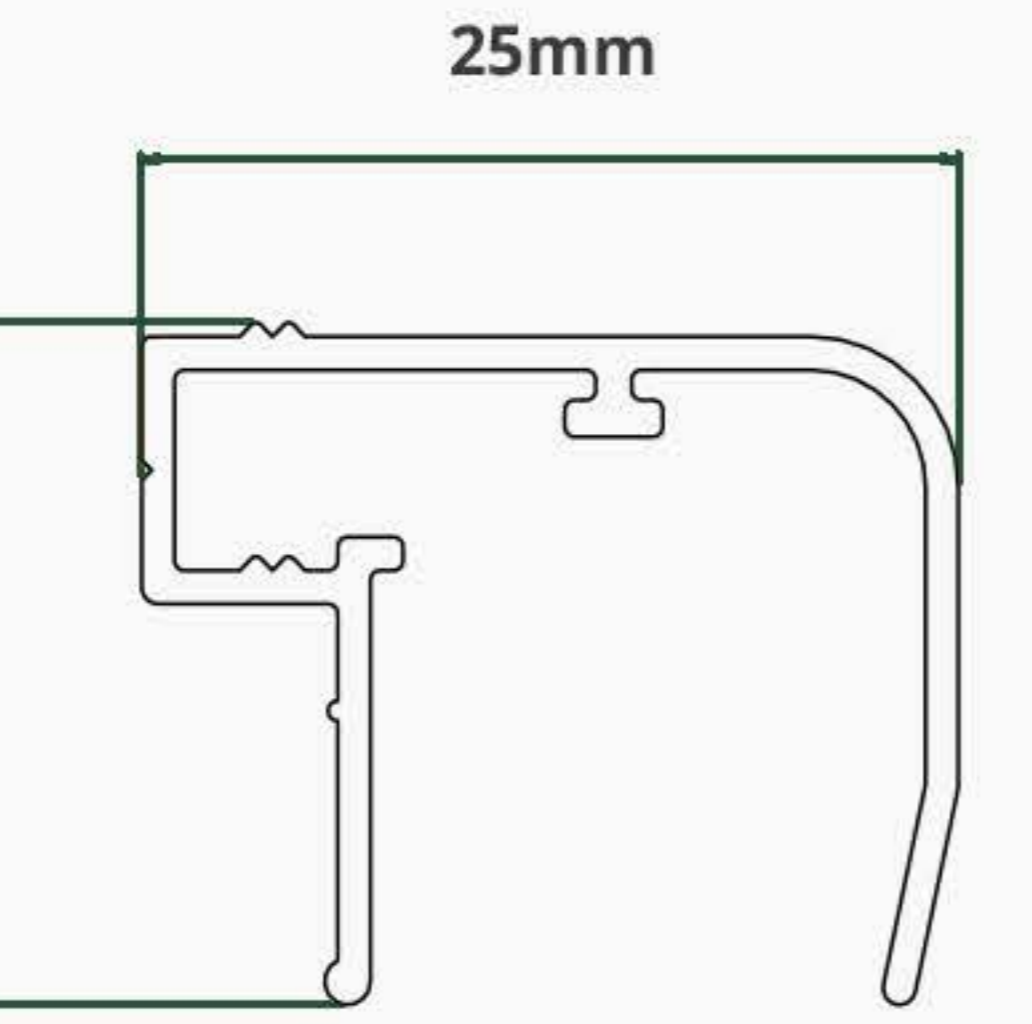
 <p>110mm</p> <p>110mm</p> <p>1. Standard Post</p>	 <p>125mm</p> <p>125mm</p> <p>2. Heavy Duty Post</p>	 <p>109mm</p> <p>102mm</p> <p>162mm</p> <p>3. Heavy Duty Gutter</p>	 <p>39mm</p> <p>147mm</p> <p>4. Wall Plate</p>	 <p>129mm</p> <p>61mm</p> <p>5. Side Roof Beam</p>
 <p>110mm</p> <p>61mm</p> <p>6. Intermediate Roof Beam</p>	 <p>110mm</p> <p>61mm</p> <p>7. Heavy Duty Intermediate Roof Beam</p>	 <p>61mm</p> <p>14mm</p> <p>8. Roof Beam Top Cap</p>	 <p>136mm</p> <p>47mm</p> <p>9. Radiused Gutter Fascia</p>	 <p>63mm</p> <p>138mm</p> <p>10. Angled Gutter Fascia</p>
 <p>12mm</p> <p>95mm</p> <p>11. Infill Fascia</p>	 <p>25mm</p> <p>20mm</p> <p>12. Nosing For Polycarbonate</p>			



Free-standing Apex Veranda

Components List

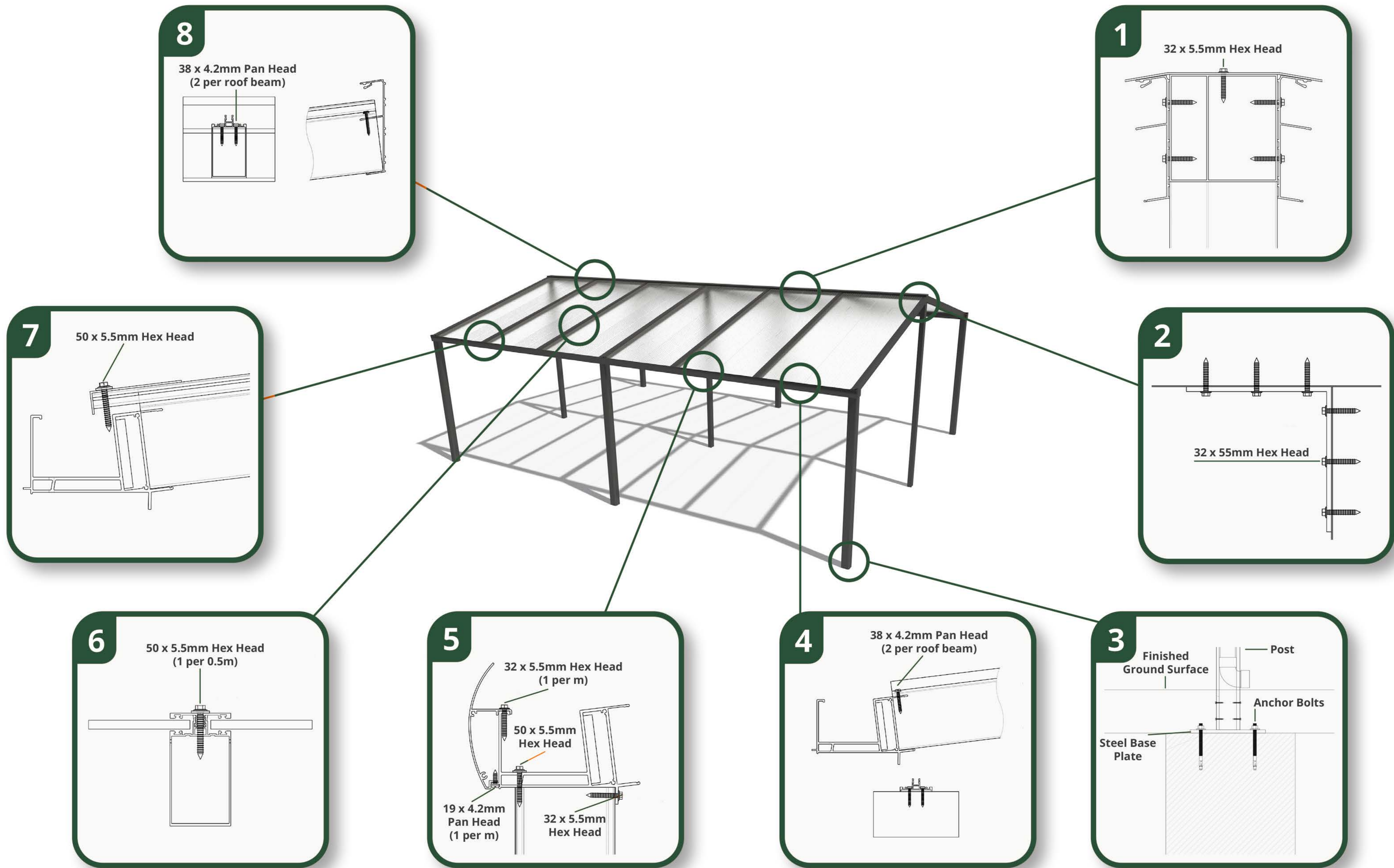



Samson

T: 01933 44 88 44

E: enquiries@samsonawnings.co.uk

W: www.samsonawnings.co.uk