

Gibus
PRICE LIST 2009

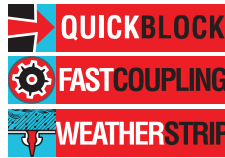

MED UNICA 130



Bearing structure in Aluminium coated with wall or ceiling fastening system on one side and supported by a bearing profile with legs for floor anchorage.

Stainless steel brackets and fusions in Aluminium coated. Fabric bands awning, sliding on RAL coated 130 mm aluminium guides and supported by aluminium coated horizontal profiles 43 x 65 mm and frontal bar 65 x 85 mm.

Toothed belt drive system on lateral guides, rotating on ball bearings.

Case made of aluminium fusions with adjustment of the belt traction.

Nylon sliding carriages with wheels equipped with stainless steel bearings and pivots.

Quick fastening of the carriage to the horizontal profile and main terminal bar thanks to the patented system "Quick Block".

The cloths are separated or partially separated, then inserted into the horizontal profile and jointed thanks to the "Weather Strip" patented system. They are further sealed with the pressure insertion of an additional nail-shaped gasket. In this way the waterproofing is perfect. Motor control standard with patented system "Fast coupling" or RTS.

In order to grant the discharge of water, the tensioned cloth version requires a minimum inclination of 15% (about 8°).

When the awning is closed and not covered a protection roof is compulsory.

Standard supplied with front waterspout and integrated water drain pipe into the legs.

	Bearing profiles guides, legs profile with groove	Brackets Feet Fusions	Protection roof made of aluminium trapezoidal shaped sheets
Standard	Anthracite 416 Stainless Steel effect White RAL 9010	Anthracite 416 Stainless Steel effect White RAL 9010	Anthracite RAL 7016 Silver metallic Ral 9006 Silver metallic Ral 9006
On request (net price)	Ivory RAL 1013	Ivory RAL 1013	Silver metallic Ral 9006 Brown RAL 8019
	Horizontal profile and terminal bars		
Standard	White Ral 9010 for PVC in White Ivory/Ral 1013 for PVC in champagne, Burgundy/Ivory, Green/champagne, Grey/champagne		
On request (net price)	Anthracite 416 Stainless steel effect		
	For different Ral colours: on quotation		

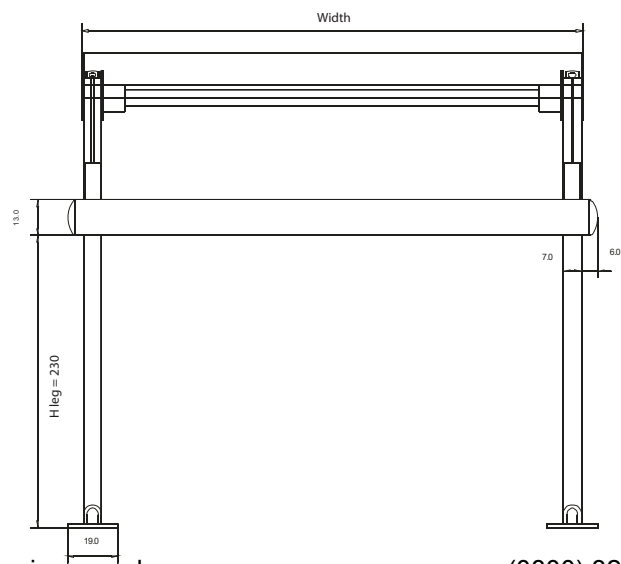
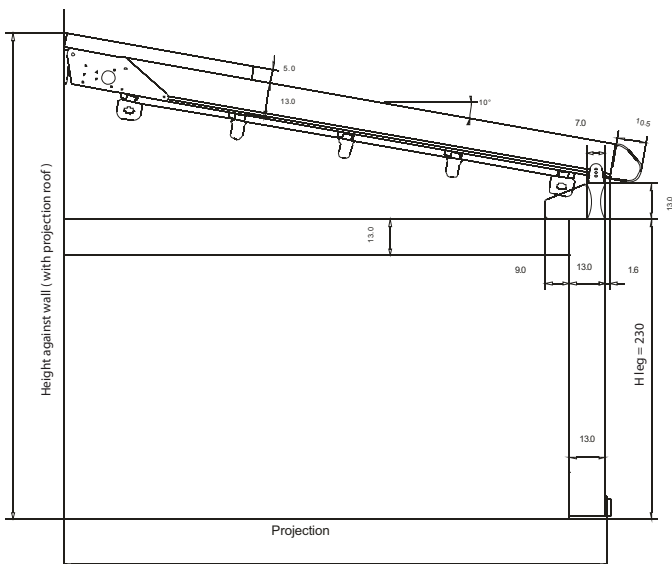

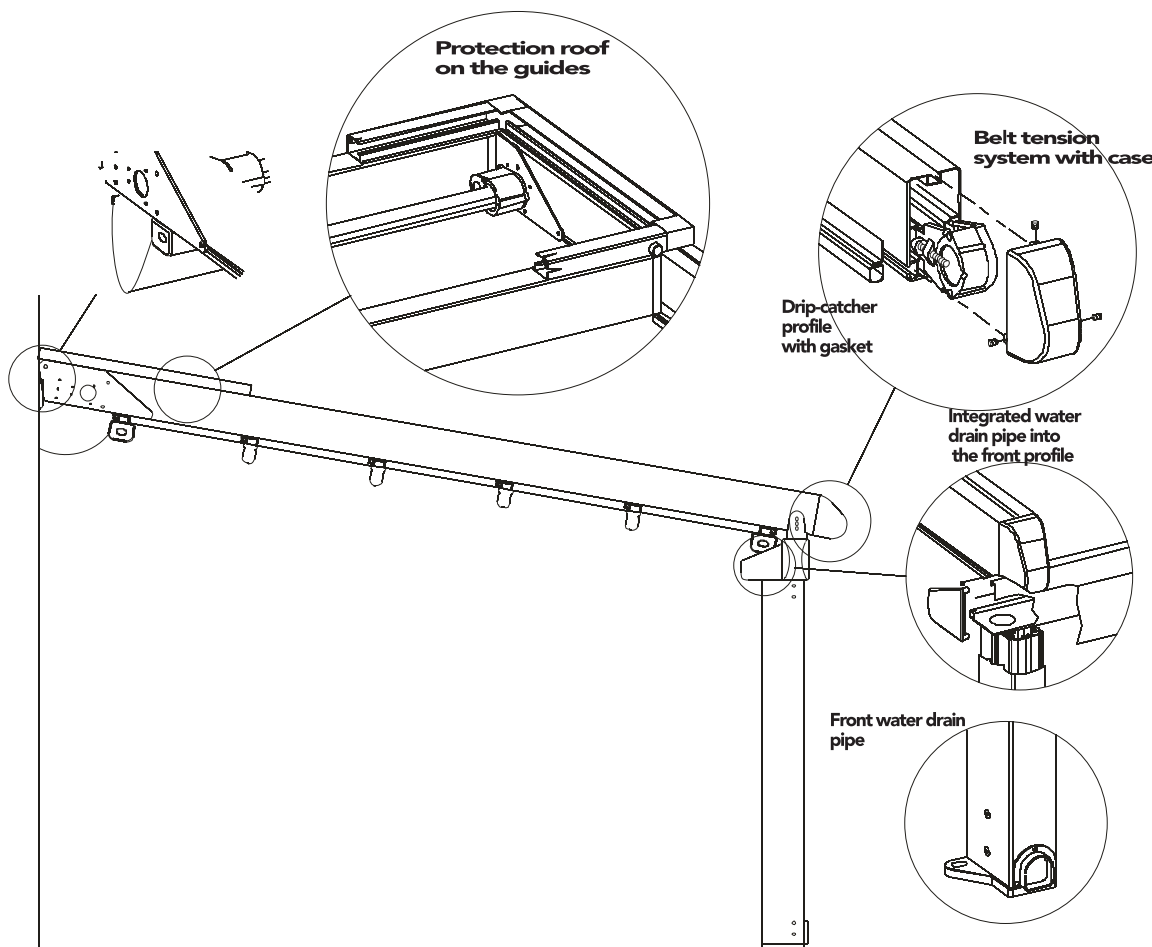

Powder coating

- For RAL colours see page 3

Fabrics

- For fabric type see page 2

Valance

- Standard : Type A cm 7

Standard

- Front water gutter with integrated drain pipe
- Minimum height in order to go under the bearing frontal bar = H cm 230

Optional

- Protection roof
- Drip-catcher system (profile and gasket)
- The lower acrylic cloth with clip fastening system to the tube d. 18. Acrylic cloth.

Aluminium Profiles

- Guide "UNICA 130" 70 x 130
- Front bearing profile 70 x 130
- Leg 70 x 130
- Bearing protection roof 70 x 130

Projection	wheelbase of the horizontal profiles	L packing		Ht Packing with protection roof 5 cm		Horizonta profile	H1
		horizontal	inclination 10°	horizontal	inclination 10°		
< 250	41—56	58—65	54—61	41—46	52—58	2—3	70
251—300	41—56	65—71	61—67	41—46	53—59	3—4	70—79
301—350	41—56	71—78	67—74	41—46	54—60	4—5	79—88
351—400	41—56	78—84	74—80	41—46	55—61	5—6	88—96
401—450	41—56	84—91	80—86	41—46	56—62	6—7	96—105
451—500	41—56	91—97	86—93	41—46	57—63	7—8	105—114
501—550	41—56	97—104	93—99	41—46	58—64	8—9	114—132
551—600	41—56	104—110	93—105	41—46	59—65	9—10	132—140

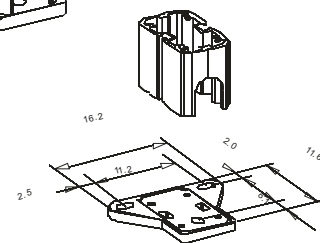
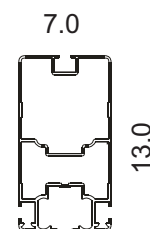
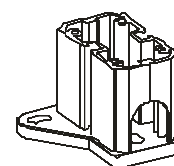
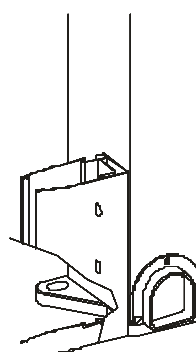
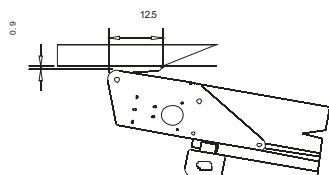
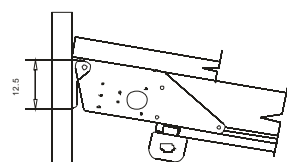
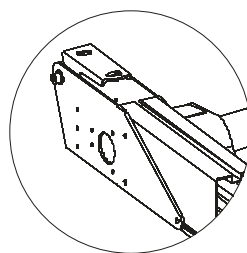
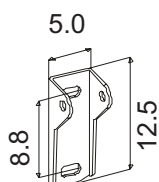
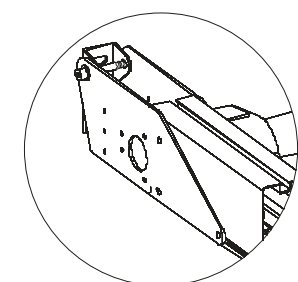
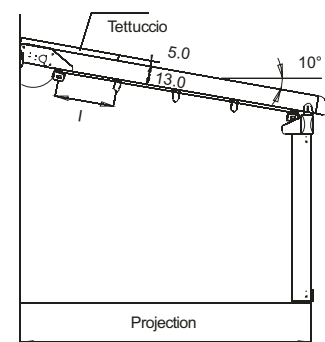
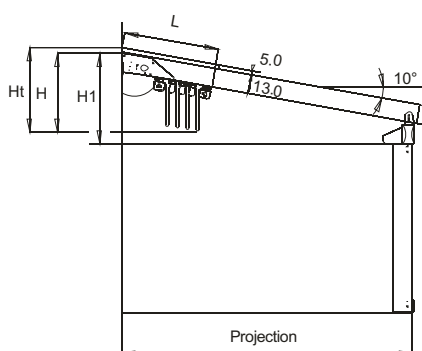

MED UNICA 130

