

safe · timeless · beautiful



## *markilux* 1550

The markilux with integrated halogen spotlights



# markilux 1550

## The markilux with integrated halogen spotlights

- design features**
- Shaped by well-known designers, given the IF Design Award for excellent design.
  - A semi-cassette folding-arm awning. The dynamically rounded coverboard gives the awning the appearance of being fully cassetted.
  - The possibility of mixing and matching the colour of the cassette with that of the end caps gives you the option of making your markilux awning your very own.
  - Elegant and robust front profile made of aluminium.
  - for long-lasting attractiveness the awning has been powder coated.

- technical highlights**
- The accented lighting of the adjustable halogen spotlights integrated into the front profile provides for a wonderful atmosphere on the patio.
  - Sturdy, round steel torque bar, 50 mm Ø, to prevent twist and deflection.
  - The 85 mm roller tube ensures the highest rigidity and the best possible cover winding characteristics even at the largest widths.
  - Coverboard with integrated brush so that larger pieces of debris cannot be drawn into the awning.
  - Attractive ovoid folding arms with unique gas piston technology ensure a taut cover in every position whether partially or fully extended.

- optional accessories**
- Hard-wired motor drive (optionally with automatic controls) for simple, relaxed operation.
  - Radio-controlled motor with handheld transmitter for ease of operation - and ergonomically crafted for ease of use.
  - Awning available in non-standard RAL colours
  - An easily connected sun and wind sensor provides intelligent control options and essential protection.
  - A dimmer allows you to adjust the lighting levels yourself.

- Beautifully crafted brackets; Design down to the last detail
- Awning covers made from acrylic fabric or sunsilk snc with self-cleaning effect
- The panel joints of the awning cover are ultrasonically bonded to give an improved appearance without bothersome stitching
- Manual operation includes a markilux stainless steel winding handle - quality to get to grips with
- Folding arms with drop-forged, aluminium joints and Teflon-coated bronze bushes to ensure high stability and longevity
- The greater upper to lower arm length ratio gives high lateral stability of the awning
- Fixture brackets are made of extruded aluminium
- Simple pitch adjustment via the bracket without necessitating readjustment of the front profile
- At larger widths one or more rolltex bearings support the roller tube
- A servo-assisted gearbox facilitates manual operation
- Awnings more than 660 cm wide can be supplied as coupled units
- An optional wall sealing profile covers the gap between wall and awning

# Folding-arm awning markilux 1550



simple pitch adjustment

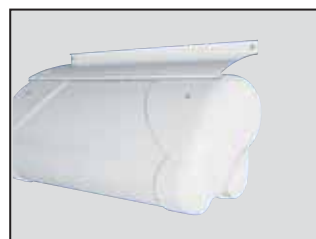

wall sealing profile (optional)



side view with awning closed, face fixture



Side view of top-fixed awning with shadeplus (optional) retracted



folding arm with gas piston

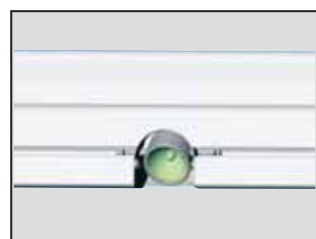

halogen illumination (optional)

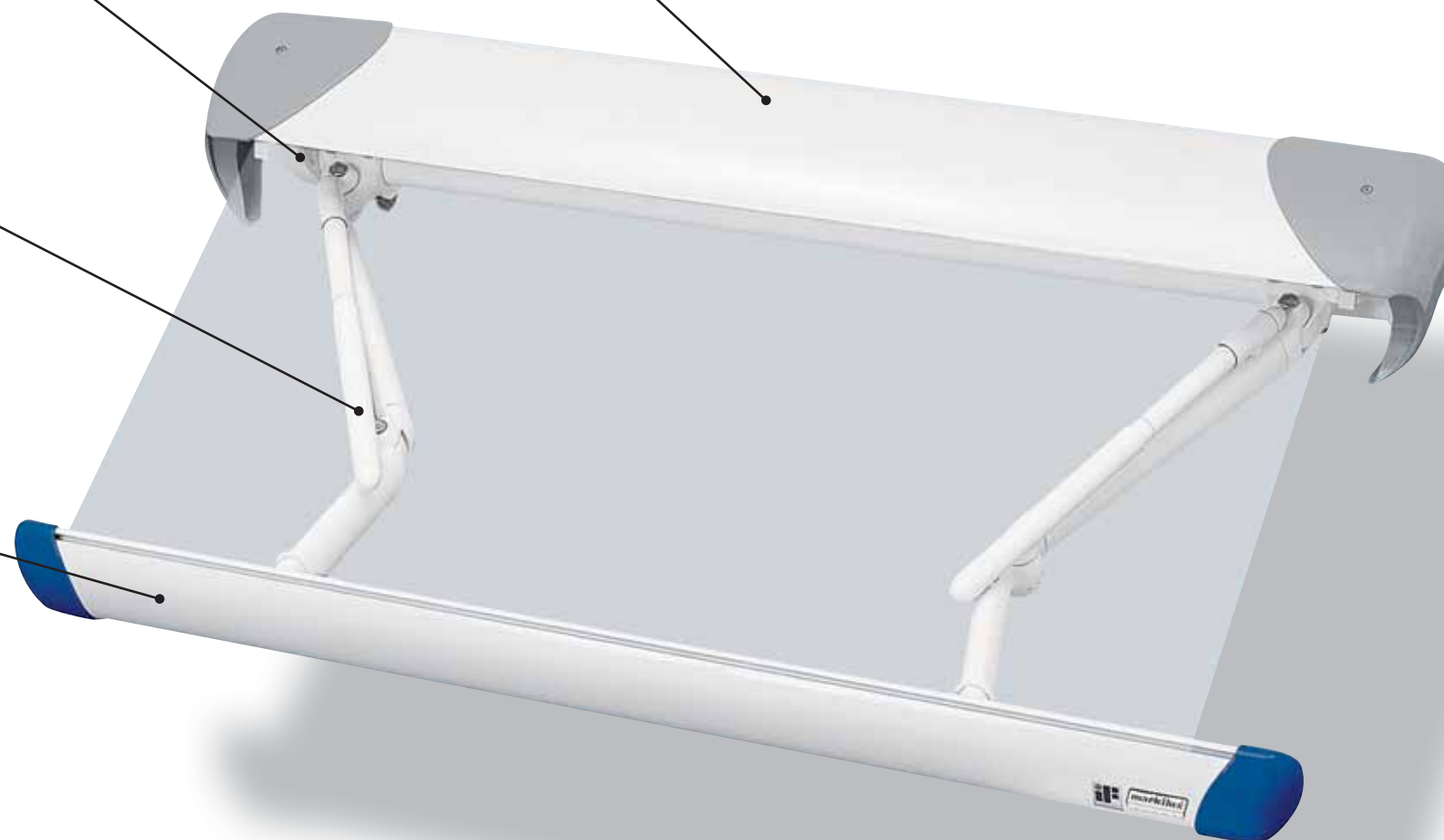

Standard RAL colours:



standard:

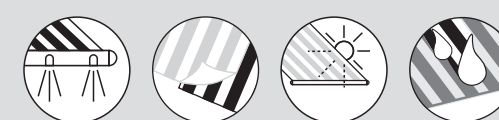

optional accessories:



safe · timeless · beautiful

**markilux 1550**



**Choice of colours**

frame colours	End caps
traffic white RAL 9016	traffic white RAL 9016
metallic aluminium RAL 9006	metallic aluminium RAL 9006
light ivory RAL 1015	light ivory RAL 1015
grey brown RAL 8019	grey brown RAL 8019
	yellow
	ruby red
	blue
	black

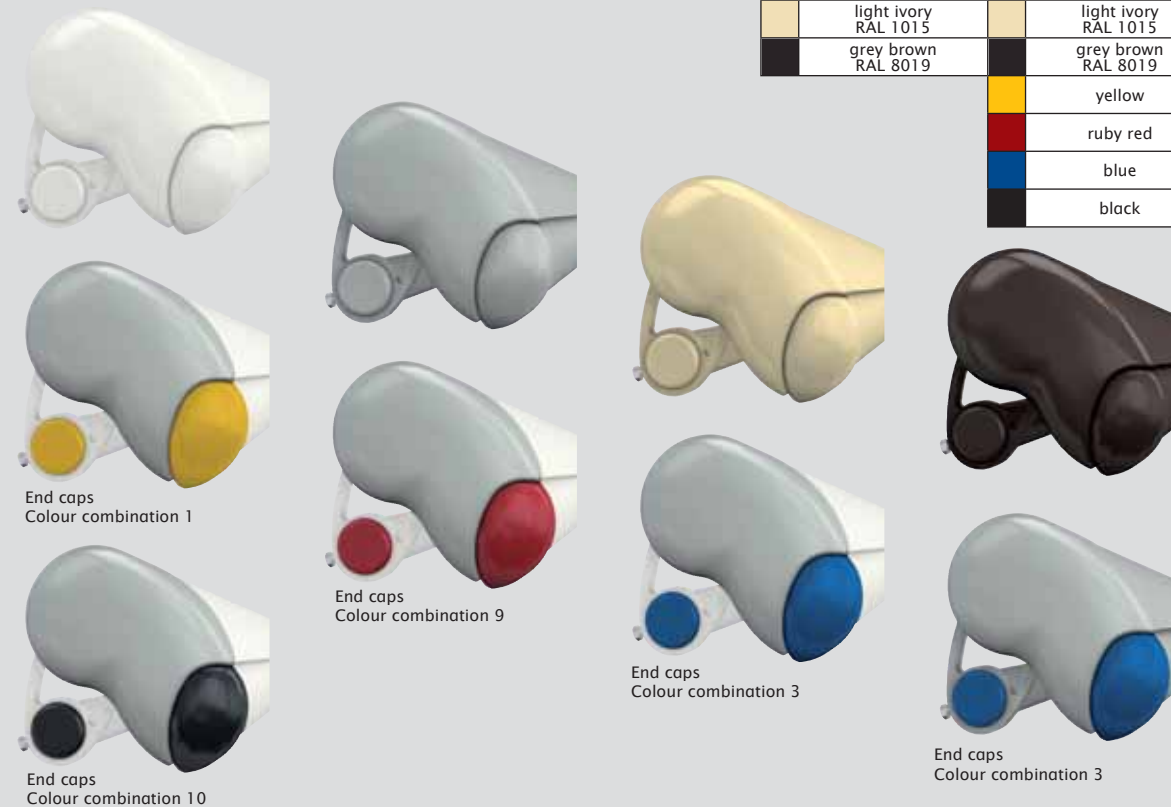

**markilux 1550 Lounge**

frame colours	End caps
Nano off-white textured finish 5233	Nano off-white textured finish 5233
Nano stone grey metallic 5215	Nano stone grey metallic 5215
Nano anthracite metallic 5204	Nano anthracite metallic 5204
	Polished chrome

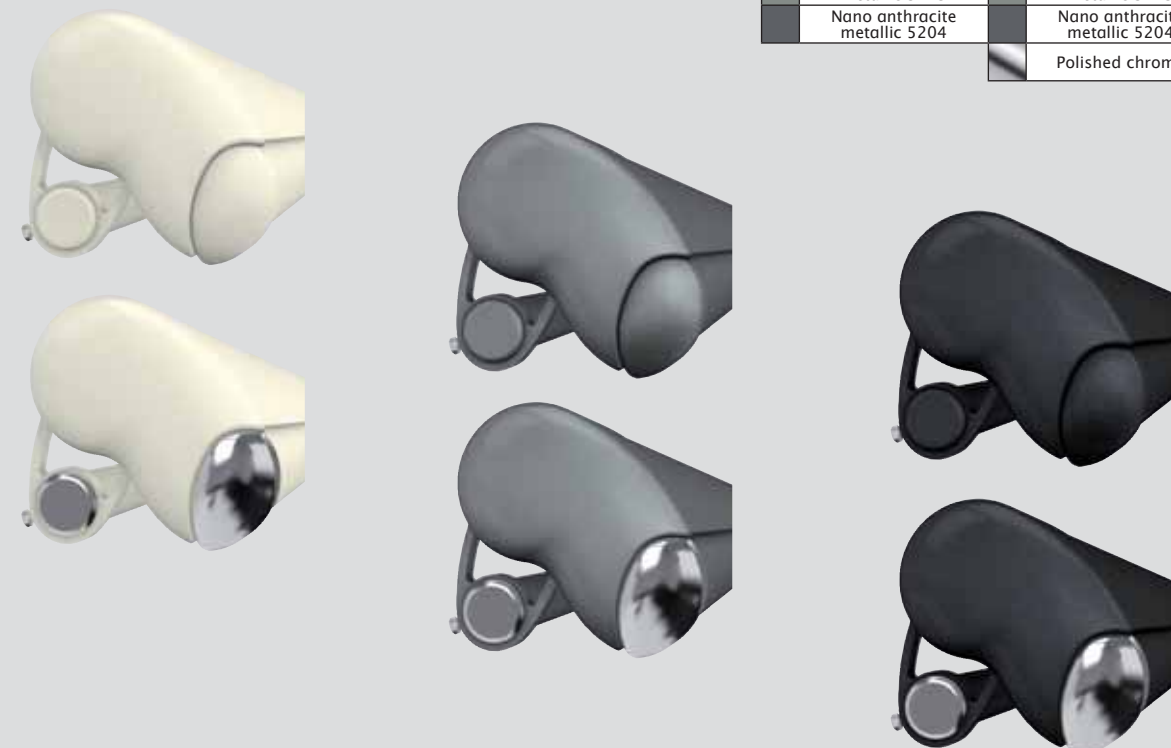

**markilux 1550**

The markilux with integrated halogen spotlights



## dimensions and configuration options

extension	Overall blind width									minimum width motor operation <sup>10)</sup>	minimum width manual operation <sup>11)</sup>
	260 193-260	310 261-310	360 311-360	410 361-410	460 411-460	510 461-510	560 511-560	610 561-610	660 611-660	Standard	standard arms
150										193	196
200	28)									243	246
250		28)								293	296
300			28)							343	346
350				28)						393	396

10) the dimensions are only valid for fixture without spreader plates (2 folding arms).

28) Please note the minimum widths!

dimensions in cm

- = available, 2 folding arms
- = available, 2 folding arms, 1 Rolltex bearing

**Definition of extension:** The extension is measured with the awning extended at a pitch of approx. 15° from the wall over the cover to the leading edge of the front profile. The extension tolerance is - 40mm / + 40mm

In the case of manual operation, assume approx. 16 winding handle revolutions per metre of awning extension.

Extension when using a motor takes approximately 12 seconds per metre.

**Coupled folding-arm awnings are available up to a max. of 2 single units positioned next to one another and only operated by motor.**

Optionally available with **junction roller**. Pattern repeat mismatches are possible in the case of junction roller covers, except when the extension is the maximum for the width of each awning. (see also arm separation table)

If coupled awnings are to be fitted into a **recess** or **reveal** the overall width of the coupled blind or awning must be at least 6 cm less than the width of the opening to allow the blind/awning to be coupled. Make a special note if the awning is to be fitted into a recess/reveal and note the reveal width separately.

operation type	
manual operation with st. steel winding handle	●
Servo-assisted operation	●
radio-controlled motor	○
motor	○
Shadeplus	
manual operation	–
radio-controlled motor	–
motor	–
Lighting	
Halogen Spotlights	●
Fluorescent lighting	–
covers	
acrylic 34 (fabric series 341xx-347xx)	●
sunsilk SNC (fabric series 324xx/329xx)	●
signature (fabric series 369xx)	●
transilk FR (fabric series 319xx)	–
transolair (fabric series 339xx)	–
widely woven acrylic (fabric series 349xx)	○ <sup>1</sup>
perla FR (fabric series 374xx/379xx)	○
Soltis 92	○ <sup>2</sup>
PVC fabric	○ <sup>2</sup>
miscellaneous	
Coverboard	–
Sytem coverboard	–
wall sealing profile	○ <sup>3</sup>
Pitch adjustment gear	–
Insertable side blind	○
sun and wind sensor	○
Valance	–
Infrared heater	○
Vibrabox / Sunis sun sensor	○
Coupled units (please refer to fixture)	
coupled unit 2 fields	○
coupled unit 3 fields	–
junction roller	○
one-piece cover (on request)	–

● = fitted as standard









○ = optional accessory

– = not available

<sup>1</sup> = widely woven fabric up to a max. extension of 300 cm; not possible in those dimensions that require a rolltex bearing





<sup>2</sup> = PVC/Soltis 92 covers available up to a max. width of 610 cm and a max. arm length of 250 cm.

<sup>3</sup> = wall sealing profile effective up to an awning pitch of 20°

frame colours		
	RAL 9016 traffic white	●
	RAL 8019 grey brown	●
	RAL 9006 metallic aluminium	●
	RAL 1015 light ivory	●
	5204 Nano anthracite metallic 5204 (Lounge)	○
	5215 Nano stone grey metallic 5215 (Lounge)	○
	5233 Nano off-white textured finish (Lounge)	○
	non-standard RAL colour	○

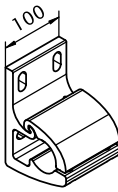
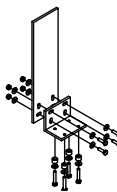
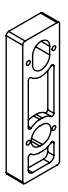
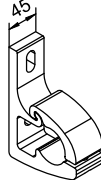
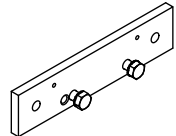
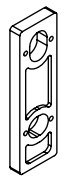
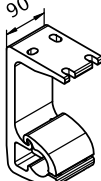
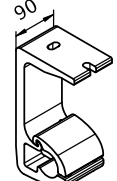
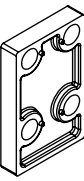
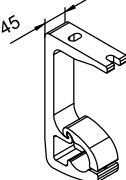
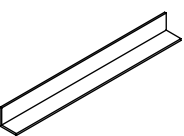
## markilux 1550

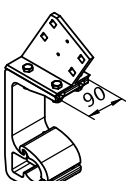
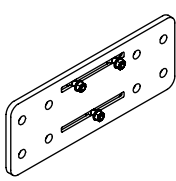
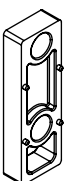
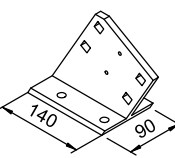
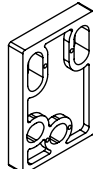
## fixings and accessories

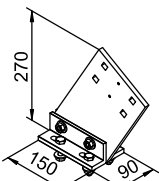
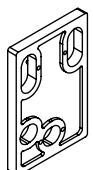
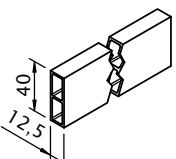
 70867.	Face fixture bracket assembly 100mm	 716620	Angle and fixture plate for eaves fixture machine finish	 718251	Spacer plate for face fixture 45x150x20mm N.B! stack to a max. of 200 mm
 71813.	Face fixture bracket assembly 45mm	 75383.	Additional eaves fixture plate 60x260x12mm	 71826.	Spacer plate for face fixture 45x150x12mm
 70868.	Top fixture bracket assembly 90mm	 70869.	Top fixture bracket assembly assembly for central fixture	 716311	Spacer plate for top fixture 90x140x20mm N.B! stack to a max. of 200 mm
 71818.	Top fixture bracket assembly 45mm	 79380.	Angled profile for eaves fixtures 100x100mm available by the metre, undrilled	 716411	Spacer plate for top fixture 90x140x12mm
 70871.	Eaves fixture bracket assembly 90mm complete set	 75326.	Component assembly spreader plate A 160x430x12mm	 716261	Spacer plate for top fixture 45x140x20mm N.B! stack to a max. of 200 mm
 71612.	Eaves fixture bracket 140mm	 718231	Spacer plate for face fixture 100x150x20mm N.B! stack to a max. of 200 mm	 716371	Spacer plate for top fixture 45x140x12mm
 71659.	Eaves fixture bracket assembly 270mm	 718241	Spacer plate for face fixture 100x150x12mm	 751971	stand-off strip for wall sealing profile available by the metre Fixture example, see face fixture with wall sealing profile

. = Please insert the RAL No. (please refer to the section on "Coatings")

## fixings and accessories

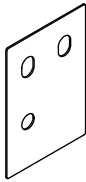
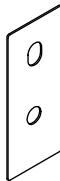
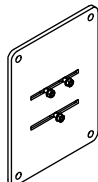
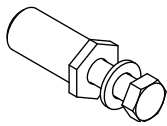
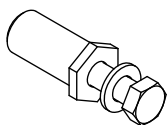
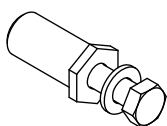
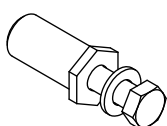
 71833.	Cover plate for external insulation  140x200x2mm
 71834.	Cover plate for external insulation  85x200x2mm
 75325.	Component assembly spreader plate B  300x400x12mm
 753891	Reduction assembly M 16 - M 12 / SW 27  50mm length (please refer to "Technical Information")
 754901	Reduction assembly M 10 - M 10 / SW 27  50mm length (please refer to "Technical Information")
 754911	Reduction assembly M 12 - M 10 / SW 27  50mm length (please refer to "Technical Information")
 754921	reducing bolt assembly M 16 - M 10 / SW 27  50mm length (please refer to "Technical Information")

. = Please insert the RAL No.  
(please refer to the section on "Coatings")

## markilux 1550

## Spotlight distribution

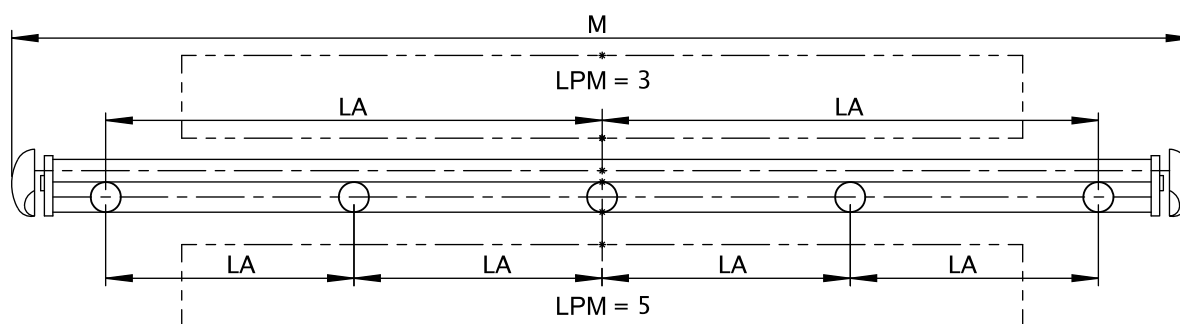

		LA					
		H [cm]					
		150	200	250	300	350	
3 LPM	M [cm]	260	80	105	-	-	-
		261 - 310	110	110	130	-	-
		311 - 360	135	135	135	155	-
		361 - 410	155	155	155	160	180
5 LPM	M [cm]	411 - 460	87,5	87,5	87,5	87,5	94
		461 - 510	105	105	105	105	105
		511 - 560	115	115	115	115	115
		561 - 610	125	125	125	125	125
		611 - 660	135	135	135	135	-

Controls for spotlighting	
Standard switch on/off	•
Radio-controlled dimmer	○

- = fitted as standard
- = optional accessory

M = overall awning width  
 LPM = no. of spotlights  
 LA = spotlight separation  
 H = extension

3 LPM -> 1 transformer  
 5 LPM -> 2 transformers

Transformer power supply: 230 V, 50-60 Hz (2.5 A)  
 Spotlight power output: 39 W  
 Light bulb: OSRAM Decostar 35 (12 V)  
 Power supply cabling in the junction box: 3 x 0.75 mm<sup>2</sup>

# Face fixture

Pull-out force [N=Newton] per fixture point according to EN 13561, wind resistance class 2

compression-proof substrate										non compression-proof substrate										
H [cm]	M [cm]										M [cm]									
	260	310	360	410	460	510	560	610	660		260	310	360	410	460	510	560	610	660	
	FB [N]										FB [N]									
150	549	627	706	784	863	941	1020	1098	1177		750	857	965	1072	1179	1287	1394	1501	1608	
200	844	965	1085	1206	1326	1446	1567	1687	1808		1154	1318	1483	1648	1812	1977	2141	2306	2471	
250	---	1361	1531	1702	1872	2042	2213	2383	2834		---	1860	2093	2326	2558	2791	3024	3257	3874	
300	---	---	2048	2276	2504	2732	3301	3561	3821		---	---	2799	3111	3422	3734	4512	4867	5223	
350	---	---	---	2936	3608	3945	4282	4619	---		---	---	---	4013	4930	5391	5852	6312	---	
HT BHT	2   100mm					2   100mm					2   100mm					2   100mm				
	---					1   45mm					---					1   45mm				
BM	6					8					6					8				

The pull-out force refers to the vertical centre to centre measurement between the fixture points of 90 mm. If this measurement is reduced, the pull-out force increases by 14% in the case of **compression-proof** substrates and by 19% in the case of **non-compression-proof** substrates. If the awning is fitted with two brackets per folding arm the pull-out force may be halved. Position the brackets to the left and right of the arm bearer.

- M = overall awning width
- H = extension
- FB = pull-out force per fixing point
- HT | BHT = bracket quantity | width
- BM = no. of fixing points
- WA = wall sealing profile

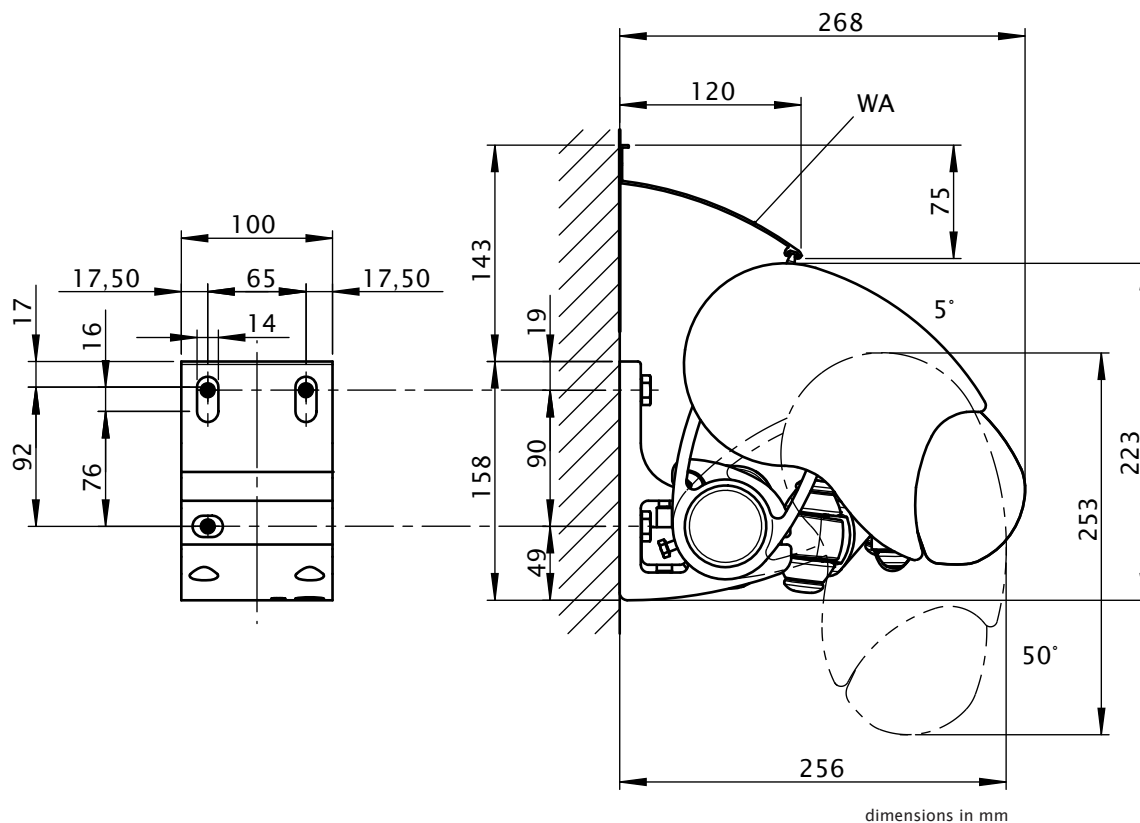

dimensions in mm

## markilux 1550

## Face fixture with spreader plate A

Pull-out force [N=Newton] per fixture point according to EN 13561, wind resistance class 2

		compression-proof substrate									non compression-proof substrate								
		M [cm]									M [cm]								
		260	310	360	410	460	510	560	610	660	260	310	360	410	460	510	560	610	660
H [cm]		FB [N]									FB [N]								
150		316	362	407	452	497	542	587	633	678	450	514	578	642	706	771	835	899	963
200		485	554	624	693	762	831	900	970	1039	690	788	886	984	1083	1181	1279	1378	1476
250		---	781	879	976	1074	1172	1269	1367	1626	---	1110	1249	1388	1526	1665	1804	1943	2311
300		---	---	1178	1308	1439	1570	1896	2045	2194	---	---	1673	1859	2045	2230	2694	2906	3118
350		---	---	---	1682	2066	2259	2452	2645	---	---	---	---	2390	2936	3211	3485	3759	---
HT BHT		2   100mm				2   100mm					2   100mm				2   100mm				
		---				1   45mm					---				1   45mm				
BP		2				2					2				2				
DP		---				1					---				1				
BM		16				18					16				18				

The pull-out force refers to the vertical centre to centre measurement between the fixture points of 76 mm.  
In the case of spreader plates a washer conforming to DIN 9021 must be used.

M = overall awning width  
H = extension  
FB = pull-out force per fixing point  
HT | BHT = bracket quantity | width  
BP = no. of spreader plates  
DP = no. of spacer plates  
BM = no. of fixing points  
WA = wall sealing profile  
75197.: stand-off strip for wall sealing profile

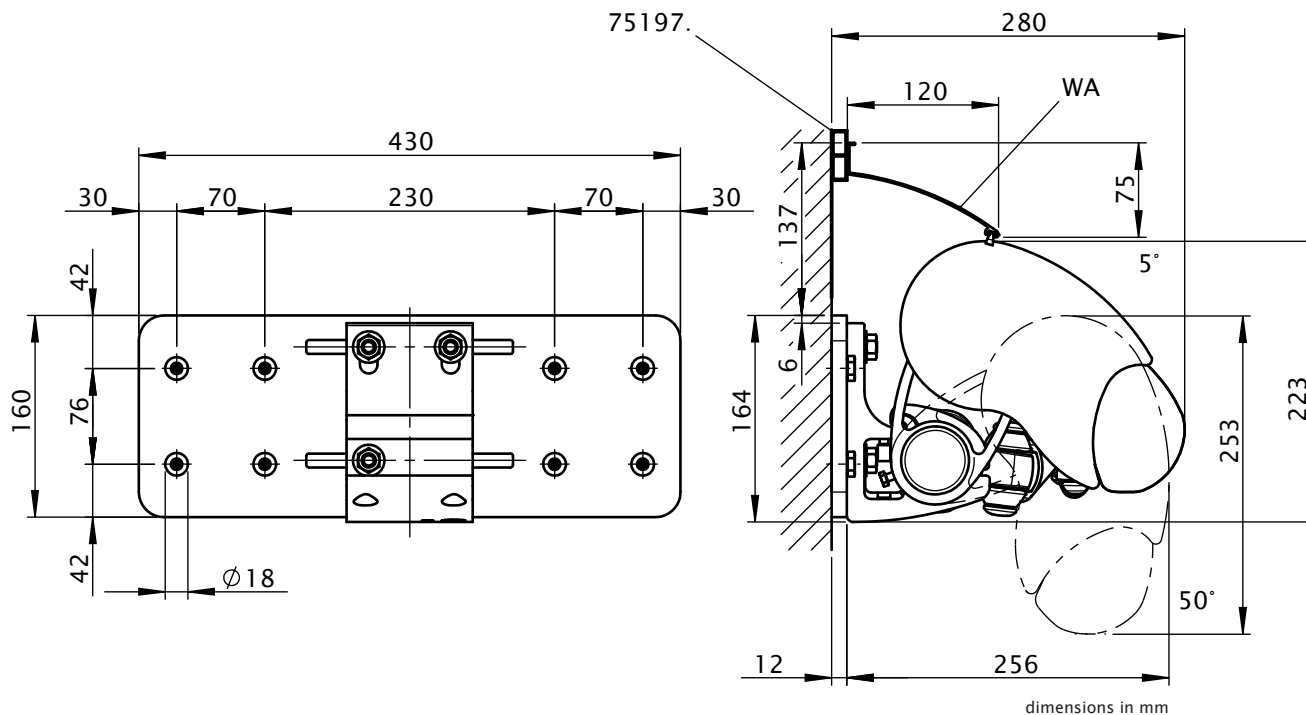



# markilux 1550

## Top fixture

Pull-out force [N=Newton] per fixture point according to EN 13561, wind resistance class 2

		compression-proof substrate									non compression-proof substrate								
		M [cm]									M [cm]								
		260	310	360	410	460	510	560	610	660	260	310	360	410	460	510	560	610	660
H [cm]		FB [N]									FB [N]								
150		708	812	917	1021	1126	1230	1335	1439	1544	909	1042	1175	1308	1442	1575	1708	1841	1974
200		1054	1207	1361	1515	1668	1822	1976	2129	2283	1363	1561	1758	1956	2154	2351	2549	2747	2945
250		---	1672	1884	2096	2308	2520	2732	2944	3485	---	2170	2445	2719	2993	3268	3542	3816	4523
300		---	---	2489	2769	3049	3328	4007	4324	4641	---	---	3239	3602	3965	4328	5216	5628	6040
350		---	---	---	3542	4341	4748	5156	5563	---	---	---	---	4617	5662	6192	6723	7254	---
HT BHT		2   90mm				2   90mm					2   90mm				2   90mm				
		---				1   45mm					---				1   45mm				
BM		8				10					8				10				

The pull-out force refers to the horizontal centre to centre separation of the fixture point of 80 mm. If the awning is fitted with two brackets per folding arm the pull-out force may be halved. Place the brackets directly left and right of the arm bearer.

M = overall awning width  
 H = extension  
 FB = pull-out force per fixing point  
 HT | BHT = bracket quantity | width  
 BM = no. of fixing points

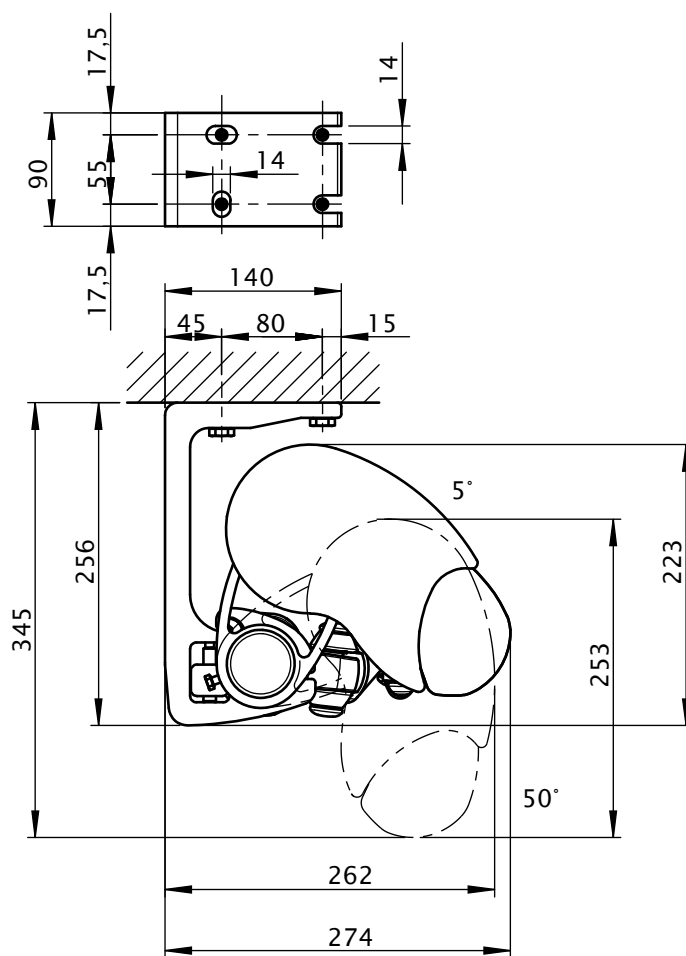

dimensions in mm

## Eaves/Roof timber fixture

Pull-out force [N=Newton] for the fixture bracket next to the arm according to EN 13561, wind resistance class 2

H [cm]	Torque										shear force									
	M [cm]										M [cm]									
	260	310	360	410	460	510	560	610	660		260	310	360	410	460	510	560	610	660	
	Md [Nm]										FS [N]									
150	135	154	174	193	212	232	251	270	289		1630	1870	2109	2349	2589	2828	3068	3307	3547	
200	208	237	267	297	326	356	385	415	445		2437	2792	3146	3500	3854	4209	4563	4917	5271	
250	---	335	377	419	461	502	544	586	697		---	3875	4366	4856	5347	5837	6328	6818	8077	
300	---	---	504	560	616	672	812	876	940		---	---	5779	6427	7075	7723	9304	10040	10775	
350	---	---	---	722	887	970	1053	1136	---		---	---	---	8231	10091	11037	11983	12930	---	
HT	2					3					2					3				
BM	8					12					8					12				

The shear force are calculated from 2 fixture points per bracket, because depending on the roof pitch it cannot be guaranteed that 4 fixture points per bracket can be used.

M = overall awning width  
H = extension  
Md = torque value for the bracket next to the arm  
FS = shear force  
HT = bracket  
BM = no. of fixing points

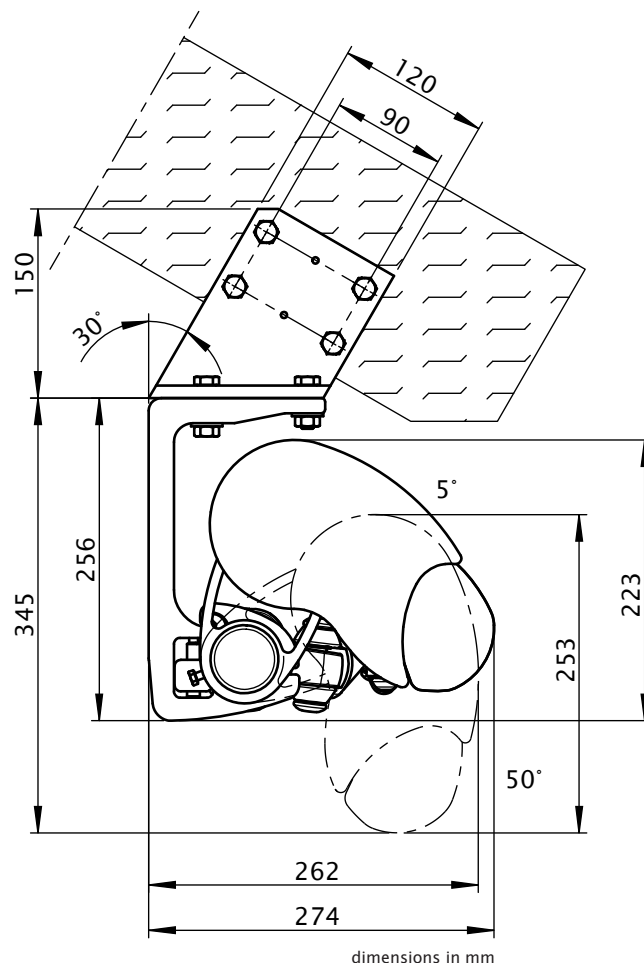

## markilux 1550

### Eaves fixture with additional plate

Pull-out force [N=Newton] for the fixture bracket next to the arm according to EN 13561, wind resistance class 2

H [cm]	Torque									shear force								
	M [cm]									M [cm]								
	260	310	360	410	460	510	560	610	660	260	310	360	410	460	510	560	610	660
	Md [Nm]									FS [N]								
150	135	154	174	193	212	232	251	270	289	805	927	1048	1170	1291	1413	1534	1656	1777
200	208	237	267	297	326	356	385	415	445	1168	1341	1515	1688	1861	2034	2207	2380	2554
250	---	335	377	419	461	502	544	586	697	---	1829	2064	2298	2533	2767	3002	3236	3816
300	---	---	504	560	616	672	812	876	940	---	---	2699	3005	3310	3616	4341	4686	5030
350	---	---	---	722	887	970	1053	1136	---	---	---	---	3817	4667	5107	5547	5986	---
HT	2			3						2			3					
BM	4			6						4			6					

By using the additional flat plate, the shear force is reduced in comparison with conventional eaves fixture.

M = overall awning width  
H = extension  
Md = torque value for the bracket next to the arm  
FS = shear force  
HT = bracket  
BM = no. of fixing points

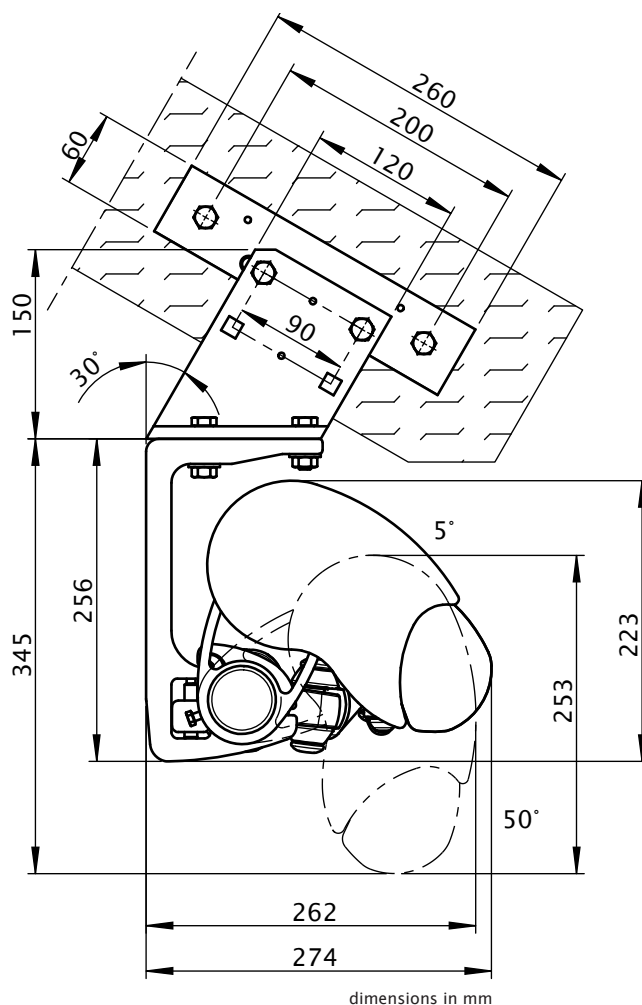

### dimensions at different awning pitches

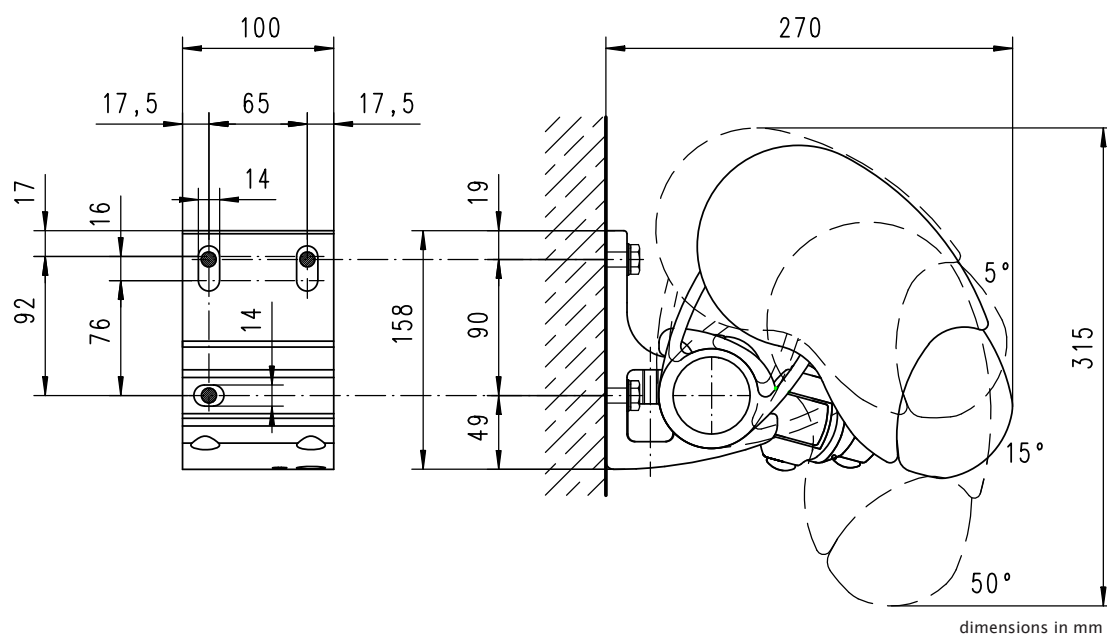

## markilux 1550

## Bracket range for awnings with 2 folding arms

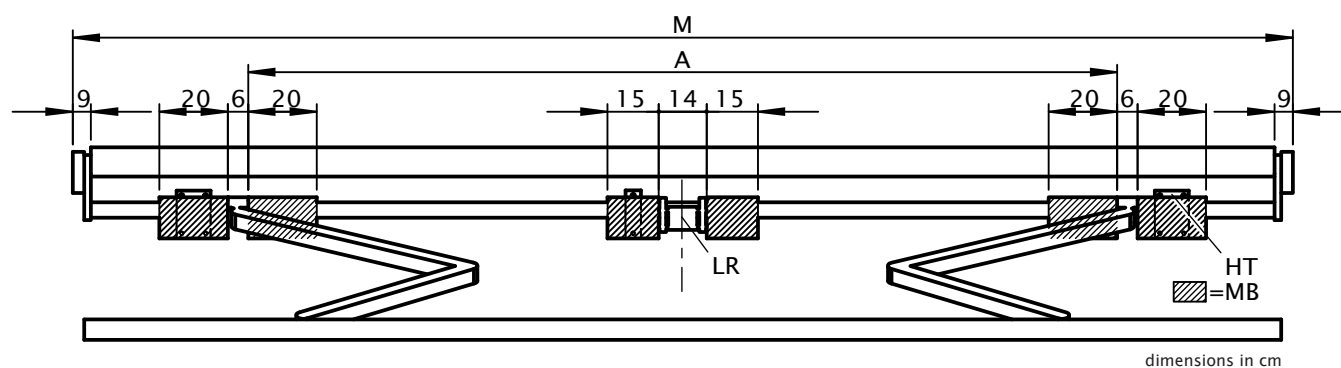

M [cm]	SB ZB	260 193-260	310 261-310	360 311-360	410 361-410	460 411-460	510 461-510	560 511-560	610 561-610	660 611-660
H [cm]	A [cm]									
	150	160 ■	220 ■	250	280	320	390	425	460	500
	200	210 ▲	220 ■	250	280	320	390	425	460	500
	250	---	260 ▲	270 ■	280	320	390	425	460	500
	300	---	---	310 ▲	320 ■	320	390	425	460	500
350	---	---	---	360 ▲	375 ■	390	425	460	---	
W	HT   BHT	45 mm	---				1			
		100 mm	2				2			
DE	HT   BHT	45 mm	---				1			
		90 mm	2				2			
DA	HT   BHT	90 mm	2				3			

dimensions in cm

▲ = Note the minimum widths! In the case of small awnings the brackets can only be fitted inside the arms, position denoted by measurement A.

■ = coupled units are only available with junction roller in the standard widths, in other widths on request

M = overall awning width  
 A = arm position  
 HT = bracket  
 MB = range for bracket fixture  
 LR = Rolltex bearing with bracket is always situated under the central seam (depends on the width)  
 SB = standard width  
 ZB = intermediate width  
 H = extension  
 W = face fixture  
 DE/DA = top fixture and eaves fixture  
 HT | BHT = bracket quantity | width

If the brackets cannot be positioned in accordance with this table, make sure the actual measurements are noted on the order form!